

Demand flexibility:
the unlocked capacity in smart
power systems

Patrizia Santoro



Unione Europea



*Ministero dell'Istruzione,
dell'Università e della Ricerca*



UNIVERSITÀ DEGLI
STUDI DI SALERNO

FONDO SOCIALE EUROPEO

Programma Operativo Nazionale 2000/2006

“Ricerca Scientifica, Sviluppo Tecnologico, Alta Formazione”

Regioni dell’Obiettivo 1 – Misura III.4

“Formazione superiore ed universitaria”

Department of Industrial Engineering

*Ph.D. Course in Electrical Engineering
(XV Cycle-New Series, XXIX Cycle)*

**Demand flexibility: the unlocked capacity in
smart power systems**

Supervisor

*Prof. Antonio Piccolo
Prof. Vincenzo Galdi*

Ph.D. Student

Patrizia Santoro

Scientific Referees

*Prof. Paola Verde
Prof. Alberto Borghetti*

Ph.D. Course Coordinator

Prof. Ernesto Reverchon

Acknowledgements

First of all, I would like to thank my family and Ivano for being my stronger supporters and helping me in the hardest moments during these years.

I would like to thank my advisors, Prof. V. Galdi and Prof. A. Piccolo for their valuable guidance, dedication, support and patience during the PhD period.

I am grateful to Prof. Gross for giving me the opportunity to spend a period in his Department under his supervision. It was a really formative experience.

I would like to express my gratitude to Giuseppe (Peppino!) and Anna for their friendships and all the nice moments we spent together, from the laughs to the intellectually stimulating talks.

Many thanks to Giovanni (il Massa), Giovanni Cat, Simona, Antonella, Francesco, Mike and all the colleagues of S.I.S.T.E.M.I Laboratory, you all contributed to make every single moments special, sweet (Antonella) and full of nice recalls.

Patrizia

Table of Contents

Table of Figures	III
Table of Tables.....	VII
List of Acronyms	IX
Papers	1
Abstract	1
Introduction	4
Chapter I	7
The role of flexibility in smart power system	7
I.1 Energy context and prospect.....	7
I.2 Renewable energy resources for a greener power system ..	10
I.3 The transition from a centralized to a decentralized electrical power system control.....	15
I.4 The new role of the distributor operators	19
I.5 The flexibility in power systems	20
I.6 Load flexibility in ancillary services	25
Chapter II	31
Demand flexibility in the energy markets	31
II.1 From demand side management to demand response	31
II.2 DR in the energy markets	34
II.2.1 Imbalance Mechanism and DR contribute	34
II.2.2 Day ahead energy market	36
II.3 Impact of demand response resources on power systems in the presence of energy storage and renewable generation..	38
II.4 Case Studies.....	44
II.5 Representative results	45
Chapter III	53
Demand modulation in distribution grids	53
III.1 DSO challenges in distribution grids.....	53
III.2 Power reduction approaches in distribution grids	54
III.3 Model of residential electrical demand	59
III.3.1 Electrical active and reactive power demand	59
III.3.2 ZIP coefficients model	60
III.4 Decentralized voltage-Led DR in low voltage distribution grids: the idea and implementation.....	63
III.5 Design of the AC/AC converter prototype	68
III.5.1 Single household regulator device	68
III.5.1.a Sensor module:	68
III.5.1.b Voltage modulator.....	69
III.5.1.c Intelligent unit: Microcontroller	69
III.5.1.d Simulation and test results.....	70

III.5.2	Dwelling voltage regulator	71
Chapter IV	76	
	Evaluation of the benefits of the fully decentralized voltage control in low voltage distribution grids	76
IV.1	Comparison between centralized and decentralized approach	76
IV.1.1	Grid description	77
IV.1.2	Load configuration	77
IV.1.3	Simulation routines and results.	79
IV.2	Fully Decentralized Load Modulation Approach to Improve DSO Flexibility in Low Voltage grids.....	86
IV.2.1	Grid description.....	86
IV.2.2	Case studies	88
Chapter V	93	
Conclusions	93	
V.I	Summary of dissertation	93
V.II	Future direction of the research	94
Reference	97	

Table of Figures

Figure I.1 World primary energy demand and CO ₂ emissions by scenario [1]	8
Figure I.2 Percentage of World residential energy consumption [[2]]	8
Figure I.3 Energy consumption by sector [[3]]	9
Figure I.4 U.S. Energy flow [4]	9
Figure I.5 U.S. Electricity flow [4]	10
Figure I.6 U.S. Electricity consumption (in billion kWh) by sector [4]	10
Figure I.7 Global renewables-based electricity generation by technology in the New Policies Scenario [1]	12
Figure I.8 Estimated renewable energy share of global electricity production, end–2015 [6]	13
Figure I.9 U.S. consumption of power produced by renewables [4]	13
Figure I.10 Typology of PV installation in Europe [5]	14
Figure I.11 U.S. residential sector distributed solar energy consumption [4]	14
Figure I.12 From grid to smart grid [9]	15
Figure I.13 Prosumer [11]	17
Figure I.14 Smart city [12]	17
Figure I.15 Typical microgrid structure [14]	19
Figure I.16 Transition of DNO to DSO [19]	20
Figure I. 17 CAISO duck curve [25]	21
Figure I.18 Flexibility resource supply curve [27]	23
Figure I.19 How demand flexibility can help manage the electricity system [23]	24
Figure I.20 Demand Flexibility [23]	25
Figure I.21 Regulation services time frames [29]	27
Figure II.1 DSM categories [36]	32
Figure II.2 Representation of DR services and their interaction with grid operator [32]	34
Figure II.3 BRP day ahead schedule [42]	35
Figure II.4 BRPs intraday options [42]	36
Figure II.5 Wholesale electricity market [55]	37
Figure II.6 DAM model [54]	38
Figure II.7 DAM with DR (Graphic adapted from [54])	38
Figure II.8 Hourly average LMP	45
Figure II.9 CO ₂ emissions	45
Figure II.10 Hourly purchase payment duration curves	46
Figure II.11 LOLP	47
Figure II.12 EUE	48
FigurII.13 Variation of LMP	48
Figure II.14 Charge v[h] (\$/MWh)	49

Figure II.15	Variation percentage of EUE	49
Figure II.16	Variation percentage of LOLP	50
Figure II.17	Variation percentage of CO ₂ emissions	50
Figure II.18	Yearly LMP average	51
Figure III.1	Load duration curve for generators [77].....	55
Figure III.2	CVR long and short term power reduction [81].....	56
Figure III.3	Primary substation peak power reduction [83].....	57
Figure III.4	Peak demand change in prototypal feeders [84].....	58
Figure III.5	Dwelling load definition [88]	59
Figure III.6	Dwelling active power demand [88].....	59
Figure III.7	Active power vs voltage [91]	60
Figure III.8	Current vs voltage [91].....	61
Figure III.9	Feeder voltage drop [93]	64
Figure III.10	LV grid with decentralized control	65
Figure III.11	Schematics of LV grid.....	66
Figure III.12	SHEMS architecture.....	67
Figure III.13	RSS block diagram.....	68
Figure III.14	Triac based converter	69
Figure III.15	TRIAC based solution prototype.....	70
Figure III.16	Simplified AC/AC converter schematics [110].....	71
Figure III.17	Switches back to back configuration [110]	71
Figure III.18	IGBT driver circuit [110]	72
Figure III.19	Switching activation [110]	72
Figure III.20	Hysteretic control [110].....	73
Figure III.21	Simulation output voltage [110].....	73
	Figure: Schematics of the AC-AC converter	74
Figure III.22	Schematics of ACAC converter [110].....	74
Figure III.23	ACAC converter prototype [110].....	75
Figure III.24	IGBT driver prototype [110]	75
Figure IV.1	LV distribution grid [112]	78
Figure IV.2	Main Routine	80
Figure IV.3	Routine A.....	81
Figure IV.4	Routine B.....	82
Figure IV.5:	Daily active power profiles at the MV/LV transformer	83
Figure IV.6	Active power regulation range	83
Figure IV.7	Feeders voltages	85
Figure IV. 8	RSS regulation.....	85
Figure IV.9	LV grid with PV panels [112]	86
Figure IV.10	Residential active power profile	87
Figure IV.11	Case A: voltages over the feeders.....	88
Figure IV.12	Case B: voltages over the feeders.....	89
Figure IV.13	Case A: percentage active power reduction.....	90
Figure IV.14	Case A: percentage current reduction.....	90
Figure IV.15	Case B: percentage active power reduction.....	91

Figure IV.16 Case B: percentage current reduction..... 92

Table of Tables

Table I.1 World Renewable consumption by scenario [1]	11
Table I.2 Smart grid technologies [10].....	16
Table I.3 Generalized product definitions for load participation in ancillary services market [31]	28
Table I.4 Regulation services for DR strategies [32]	28
Table III.1 Reserve type CLASS service [80]	56
Table III.2 ZIP parameters [89]	63
Table III.3 Current Harmonics.....	70
Table IV.1 LV grids cables parameters [112]	78
Table IV.2 LV grid feeders' length [112]	78
Table IV.3 Comparison of control techniques (case A)	84
Table IV.4 Comparison of control techniques (case B)	84
TableIV.5 LV grid parameters [112].....	87

List of Acronyms

AC	Alternating Current
NP-RES	Not programmable renewable energy sources
RES	Renewable Energy Sources
PV	Photovoltaics Resources
ISO	Independent System Operator
EUE	Expected Unerved Energy
LOLP	Loss of Load Probability
DR	Demand Response
DRR	DR Resources
LMPs	Locational Marginal Prices
ESS	Energy Storage System
DSO	Distribution System Operator
CVR	Conservation Voltage Reduction
OLTC	On load tap changer
LV	Low Voltage
MV	Medium Voltage
FD-PC	Fully decentralize Power Control
IEA	International Energy Agency
CSP	Curtailement Service Providers
DNO	Distribution System Operator
DER	Distributed Energy Resources
TSO	Transmission System Operator
DSM	Demand Side Management
BRP	Balance Responsible Parties
DAM	Day Ahead Energy Market
RTO	Regional Transmission Organizations
IGO	Independent Grid Operator
EMCM	Transmission-Constrained DAM Clearing Model
DR-SP	DR Service Providers
RSS	Regulating Smart Socket
RU	Residential Unit

Papers

- P. Santoro, V. Galdi, V. Calderaro, G. Gross, “Quantification of Variable Effects of Demand Response Resources on Power Systems with Integrated Energy Storage and Renewable Resources”, in *Proc. of 2015 IEEE Eindhoven PowerTech.*, 2015
- P. Santoro, V. Galdi, V. Calderaro, A. Piccolo, “Active Smart Socket Design to Perform Local Control of Power Demand in Residential Units”, in *Proc. of Power Electronics, Machines and Drives (PEMD 2016), 8th IET International.*, 2016
- P. Santoro, V. Galdi, V. Calderaro, A. Piccolo, “A Comparative Study of Centralized and Decentralized Active Power Control in Residential Energy Districts”, in *Proc. of 16 IEEE International Conference on Environment and Electrical Engineering (EEEIC), 2016*
- P. Santoro, V. Galdi, V. Calderaro, A. Piccolo, “A Comparative Study of Centralized and Decentralized Active Power Control in smart residential area”, *IEEE Transactions on Industry Applications* (under review)
- P. Santoro, V. Galdi, V. Calderaro, A. Piccolo, “ A Fully Decentralized Load Modulation Approach to Improve DSO Flexibility in Low Voltage grids”, *2017 IEEE Eindhoven PowerTech* (under review)

Abstract

In the next years, it is expected a deep growth of world primary energy and electricity demand. The scenarios prospect a positive rate in all the sectors, especially in the residential one. In particular, residential sector is one of the major consumer of electricity and this situation will be intensified by the awaiting spread in large scale of electric vehicles and heat pumps.

For what concerns the generation of electricity, the penetration of not programmable renewable energy sources (NP-RES) is significantly increasing, especially photovoltaics resources (PV) are experiencing a large distribution between small consumers, as small commercial and residential. The presented energy scenario is leading the grid operators to face issues in managing the grid due to both the uncertainty in the load profiles and in the generation production from NP-RES. Furthermore, the deeper use of NP-RES, such as PV, introduced new critical situations that must be solved by the grid operators in order to run the system in a safe and reliable way. One of these situations is well depicted in the *duck curve*, which represents the system net load in CAISO (California Independent System Operator), where are highlighted both the *overgeneration risk* and the *high rate ramps* problem. The former occurs when the *net load* is close to the *base load* generation units total capacity, whereas the latter occurs during the sunset in which the PV panel generation decreases quickly, driving the *net load* to increase in a short period of time. The uncertainty, the ramp risks and all the issues related to the strong penetration of NP-RES, led grid operators to involve more balancing generation units with a consequence increase of the energy price. A more sustainable and economic solution is the deployment of flexible resources in the grids, such as energy storage resources and demand flexibility. By using these technologies and techniques, the grid operator can achieve a stronger control on the grid and through their coordination, it can manage the grid in a more efficient and reliable way to face all the events in the grid and guarantee the equilibrium between generation and demand around the clock.

In this PhD dissertation, the focus is on demand side flexibility and how it can be managed from grid operators, from transmission to low voltage distribution grids.

In order to use demand side flexibility, demand response programs (DR) have been introduced. DR programs are mostly diffused in energy markets and therefore they impact on transmission grids in terms of congestions, expected unserved energy (EUE) and loss of load probability (LOLP) parameters. In USA the use of DR resources (DRRs) is well regulated and they actively participate in the energy markets to get economic benefits such as reduction of the energy prices (locational marginal prices). Furthermore, there is a strong regulation about their remuneration (FERC Order No. 745) and as consequence, the presence of DRRs is quickly increasing. DRRs are also involved in emergency situations, for example when grid issues occur. In this dissertation, the focus is on economics DR programs and their impact on transmission grid reliability, economics and emissions metrics. The performed study aims at providing insights into the impacts of deepening penetration of DRRs under different intensity levels in the presence of energy storage systems (ESSs), as pumped-hydro storage and compressed-air energy storage, and wind power plants. The results show that with a high number of DRRs and using the maximization of the social welfare as clearing optimization criterion, the performance of the system in terms of reliability metrics (EUE and LOLP) gets worst, instead in terms of economics and emissions parameters there is a significant positive impact. The research results show that if the number of DRRs is not less than 20% of the total number of the transmission grid buses, all the metrics (reliability, economics and emissions) are positive, ensuring a relief effect on the system.

If DR programs are well described and regulated in the energy markets and therefore they influence the transmission grid as both scheduled and real time resources, in the low voltage distribution grid, DR programs are still not available by grid operators as balancing or reserve resources. This is mostly due to the high percentage of residential customers in low voltage distribution grids whose daily power consumption is strongly related with their behaviors and they put their comfort on the foreground. Furthermore, the almost total absence of DR aggregators for residential customers and the lack of technological devices make the residential sector be a locked capacity for the distribution system operators (DSOs). Literature and some pilot projects (for instance the European project ADDRESS and the UK project CLASS) aim at investigating the opportunity offered by this sector and exploring techniques and technological solution to exploit its flexibility in balancing the distribution grids. In particular, in literature it is investigated the opportunity to modulate the dwellings power by modifying the supplying voltages, as by using Conservation Voltage Reduction (CVR) technique. This approach is developed according to the relationship between voltage and power, described by the exponential and polynomial model, called ZIP

model. In literature, the power modulation is achieved modifying the position tap of *on load tap changer* (OLTC) primary distribution transformer in order to modulate the voltages over the feeders. Even if this approach shows a good level of power reduction in low voltage distribution grids with high penetration of residential units and customers do not notice any lack of quality service in the supplied voltage, the main limitation of this technique is its centralized nature. It is applied to the primary substation and therefore it involves all the customers connected to the grid and since the supplied voltages must be inside the limits set by the standard CEI EN 50160, downstream users are the bottle neck of this technique because they set the lower limit of the voltage regulation.

In this dissertation it is applied a fully decentralize power control (FD-PC) based on a decentralized voltage control in order to achieve the active power modulation by residential end-users when the DSO needs (for instance, when the cables or transformers are overloaded). Voltage modulation can be executed inside a single or cluster of residential units; here a smart home energy management system (SHEMS) to be installed inside a dwelling and able to receive signal from the DSO is suggested, in order to modulate the dwellings voltage using AC/AC converters. The FD-PC is tested on a LV distribution grid and compared with a CVR based solution applied to the secondary distribution transformer. The FD-PC shows better results in terms of power reduction compared with the centralized technique since it applies a different percentage of voltage reduction according to the voltage values measured at the selected points. In this way, it is possible to use all the regulation range set by the standard. In addition, the voltages over the feeders are not directly involved in the voltage regulation as in the centralized technique, therefore the system has better performance in terms of voltage security margins. Another interesting result is obtained in LV grids characterized by low voltage levels (close to the standard lower limit) on the feeders. It is analyzed the case study in which the OLTC secondary distribution transformer is set equal to 1.05 p.u. in order to increase the voltages in the feeders and assure that the upper and lower limits are respected. In this situation, the FD-PC gains better results, providing an active power reduction almost double compared to the base case. All the simulation studies are performed using a Monte Carlo approach in order to define random residential demands and allocation of PV panels, when included in the network. The simulation period is one day and the simulation step is equal to 10 minutes.

Introduction

Even if the growing concern about the environmental issues has led to a major interest in the sustainable development of power systems, the world primary energy and electricity demand is expected to increase in the next years. In fact, according to the International Energy Agency (IEA), the electricity consumption grows by more than 70% from 2013 to 2040, mostly due to the electrification of sectors as transportation and the increasing electric demand in areas with new emerging economies, such as India and China. Among the sectors where there is more demand for electricity, there is the residential one, since it represents around 30% of the total consumption.

For what concerns the power generation, the forecasted scenario is more promising: according to IEA, by 2040, renewables-based generation reaches 50% in the European Union, around 30% in China and Japan, and above 25% in the United States and India. The NP-RES are experiencing a positive trend during these years. In particular, the deployment of PVs is growing very fast in the residential sector due to tax incentives and a more consciousness energy behavior of end consumers.

The depicted expected growing penetration of both RES, in particular NP-RES, and electricity consumption is leading the grid operators to face new issues in the power grids. The power generated from NP-RES strongly impacts on the grid management due to their intrinsic uncertainty on the power availability. Therefore, the need for new and more extensive control actions to balance supply and demand for both energy and power is put on the foreground. Grid operators can act both on the generation side and on the demand side. For the former, it is possible to use more balancing generation units and peak loads units, but this solution leads to a not sustainable and expensive power system management.

The deeper involvement of electrical demand in the grid control, such as DR programs and ESSs, is the most meaningful and promising consequences of this new scenario. In particular, DR begins to support the achievement of supply-demand balance around the clock. As it is shown in USA, DR programs are well-established opportunities for retail consumers to be active participants in the electricity markets, from capacity to real time markets.

The application of DR programs makes possible financial benefits, such as the reduction of energy price and price volatility during the peak hours and they allow the achievement of system advantages as deferral of short-term upgrade of the transmission and distribution infrastructures, reliability improvement and reduction of carbon dioxide emissions. In the DR programs, retail consumers are aggregated into groups called *curtailment service providers* (CSPs) which offer in the market to cut the electrical loads when required, i.e. during emergency conditions (emergency DR programs) and/or when the wholesale prices are high (economic DR programs).

DR programs are deeply regulated in the energy markets and therefore they are deeply involved in the markets, as both scheduled and real time resources.

In LV grids, DR programs are still not available and easy to be applied by grid operators due to the high uncertainty of residential electricity demand. Furthermore, in the recent years, LV grids evolved from passive (traditional) to active grids by the introduction of new distributed energy resources, such as PV panels and prosumers. The request of flexibility to maximize the coordination between each element to face ramp issues, under/over generation risks and guarantee the match between generation/demand has led grid operators to introduce new technologies and strategies to manage in real time all the new entities.

The PhD dissertation is developed according to the reported scenario. The focus is on the management of demand flexibility both in energy markets and in LV grids. In particular, for the former, it is presented a *what if* analysis to provide a deeper understanding of DRRs. For the latter, it is proposed a decentralized control in order to unlock the potential of residential power demand in providing power reserves to the DSOs.

The structure of the PhD dissertation is as follows.

In Chapter I, the energy reference context is presented, both in terms of demand and generation. For what concerns the generation side, in order to explain the issues related to the diffusion of NP-RES, a representative example is discussed to pinpoint the risks that grid operators must take on. The transition from traditional power systems to smart grids is explained and the need for flexibility in the system is presented with the options available for the DSOs.

In Chapter II, Demand Response (DR) programs are presented and the role of DR in the energy markets, day ahead and real time, is illustrated. The reported case studies aim at providing insights about limits and opportunities in using DR programs in U.S. day ahead markets.

In Chapter III, a novel service for the DSO is introduced to provide flexibility in LV grids using residential power consumption as power reserve to be exploited when overloading or mismatch condition occurs. The solution is based on the Conservation Voltage Reduction (CVR) technique principle but it is applied in a decentralized way, close to the residential

units. A technological solution is described and proposed in order to deploy the introduced service.

In Chapter IV, selected simulation studies are carried out in order to compare the proposed service results with the approach presented in literature, e.g. CVR based technique, in order to highlight the advantages introduced by the novel service. The simulations are performed using a stochastic simulation approach.

In Chapter V the conclusions remarks and the future research direction are presented.

Chapter I

The role of flexibility in smart power system

I.1 Energy context and prospect

The world primary energy demand is going to increase in the next years with a degree of growth dictated by the government policies, as shown in [1]. In particular, in this document, three main policy approaches are described: *new policies scenario*, which incorporates the policies and measures in the energy sector adopted as of mid-2015 or that the governments plan to apply; the *current policies scenario* includes only the policies formally adopted and implemented as of mid- 2015 and it assumes that they will not change in the future; the *450 Scenario* which includes all the approaches adopted to limit the rise in the long – term average global temperature to two degrees Celsius [1]]

In Figure I.1, it is represented the growth of the world primary energy demand from 1990 to 2040. From 2013 to 2040 the primary energy demand is expected to increase by 45% in the *current policies scenario*, 32% in the *new policies scenario* and 12% in the *450 scenario*, [1]. In the same figure, it is reported the trend of the energy related CO₂ emissions which follows the energy demand trend for the *current scenario*, has a weaker relation in the *new policies scenario* and has not relation in the *450 Scenario*, where the approaches allow the use of programs to reduce the pollution.

The power sector is the main contributor in the growing of the primary energy demand since it accounts for 55% of the total. The electricity demand rate of growth is very significant: it is equal to 2.0% per year the *new policies scenario*, 2.3% per year for the *Current policies scenario* and 1.5% per year for the *450 Scenario*. Therefore, the demand is expected to increase over 70%, 79% and 57% in 2040 compared to the one registered in 2013 in the *New Policies*, *Current* and *450 Scenario*, respectively.

Chapter I

The building sector expects a demand rising by 75% to 2040, representing the largest electricity consumer [1].

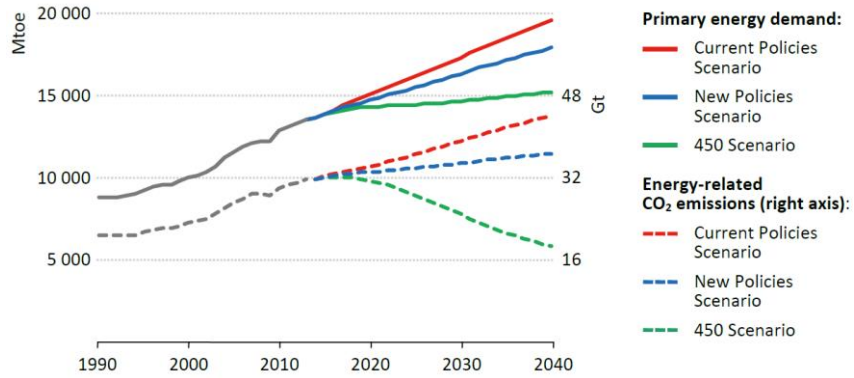

Figure I.1 World primary energy demand and CO₂ emissions by scenario [1]

Furthermore, buildings account for around 40% of global energy consumption and three-quarters of the total energy consumption is due to the residential sector as reported in Figure I.2 for the different regions of the world [2].

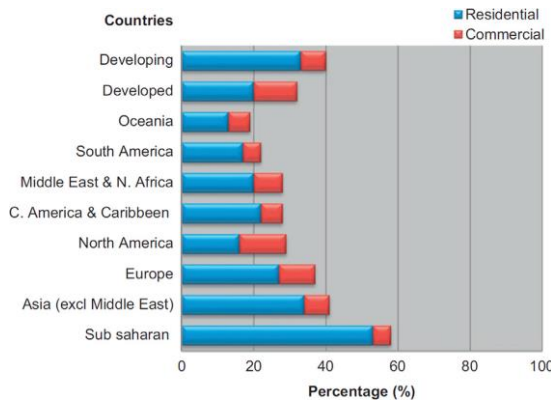

Figure I.2 Percentage of World residential energy consumption [[2]]

The residential sector accounts for the 27% of the total energy consumption in the world, placing as the third largest major consumption (Figure I.3) [3].

The main energy resources in the residential sector are biomass and waste, electricity, natural gas and oil products but electricity consumption is growing three times faster than the other energy resource [2].

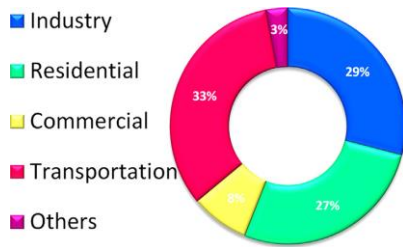

Figure I.3 Energy consumption by sector [[3]]

Following, the U.S. residential data are reported in order to provide an insight. In 2015, about 20% of U.S. energy consumption was consumed in residential sector as shown in Figure I.4 [4].

U.S. Energy Flow, 2015
quadrillion Btu

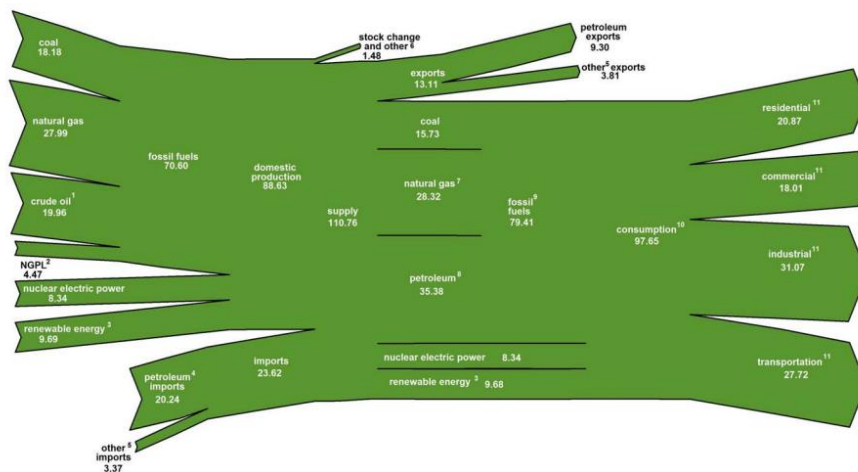

Figure I.4 U.S. Energy flow [4]

In particular, the electricity consumption is reported in Figure I.5, which represents about 36% of the total end user electricity consumption [4].

Indeed, the electricity consumption in residential sector really depends on the weather conditions even if it shows a closely resembling periodical waveform. An example is shown in the Figure I.6 [4], where it is shown the variability of the electricity consumption (in billion kWh) by sector. Data are collected up to August 2016.

About Winter 2016-2017 it has been prospected an increasing of 2.4% in the electricity consumption due to the cooler temperatures. The electricity consumption is mostly connected to the lighting usage and in USA, some homes heat with primary heating equipment, such as electric furnaces or heat

Chapter I

pumps, or with secondary heating equipment, such as space heaters or electric blankets [4].

U.S. Electricity Flow, 2015
quadrillion Btu

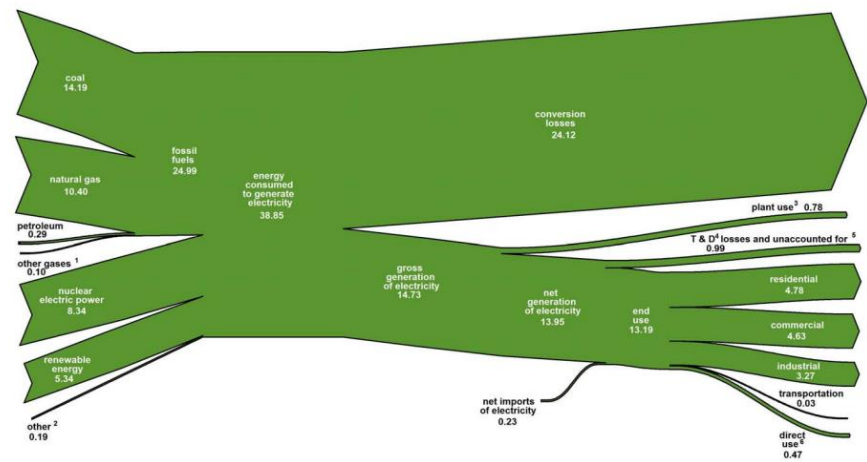

Figure I.5 U.S. Electricity flow [4]

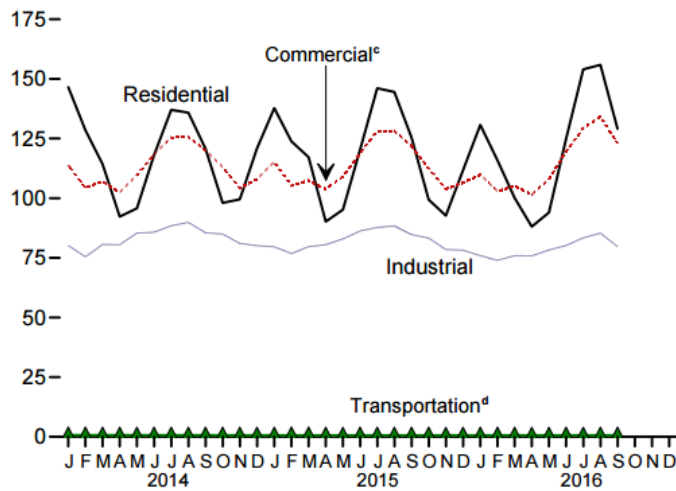

Figure I.6 U.S. Electricity consumption (in billion kWh) by sector [4]

I.2 Renewable energy resources for a greener power system

Due to the environmental concern, the use of renewable energy sources is a key component in the energy policies of all the Countries in the World.

Renewable energy sources can be grouped into two groups: *dispatchable* or *controllable* (such as hydro power, geothermal and biomass) and *not dispatchable* or *not controllable* (such as wind, solar photovoltaics).

The dispatchability depends on the ability to control the resources according to system requirements. Due to the intermittent nature of not *dispatchable* resources, system operators cannot fully plan the electricity generation from these sources and only a small amount of the installed capacity can be considered as statically dispatchable and a back-up capacity is required [5].

In 2014, RES were the second largest source of electricity behind the coal and in the last decade, lots of renewable plants were built, that is 318 GW of hydropower, 304 GW of wind power and 173 GW of solar PV and compared to 2013, renewables accounts for 85% of increase in total power generation [1]. In Table I.1 the table of the world renewable consumption by scenario is presented.

	2013	New Policies		Current Policies		450 Scenario	
		2025	2040	2025	2040	2025	2040
Primary demand (Mtoe)	1 863	2 507	3 346	2 423	3 030	2 687	4 388
United States	147	217	323	201	286	258	499
European Union	209	292	378	277	342	309	457
China	331	448	589	430	517	485	808
<i>Share of global TPED</i>	14%	16%	19%	15%	15%	19%	29%
Electricity generation (TWh)	5 105	8 784	13 429	8 202	11 487	9 549	17 816
Bioenergy	464	902	1 454	865	1 258	973	2 077
Hydropower	3 789	4 951	6 180	4 854	5 902	5 083	6 836
Wind	635	1 988	3 568	1 701	2 778	2 344	5 101
Geothermal	72	162	392	143	299	197	541
Solar PV	139	725	1 521	593	1 066	862	2 232
Concentrating solar power	5	50	262	41	147	83	937
Marine	1	6	51	5	37	7	93
<i>Share of total generation</i>	22%	29%	34%	26%	27%	34%	53%

Table I.1 World Renewable consumption by scenario [1]

It is possible to note that total electricity generation from RES is expected to increase by 125-250 % compared to 2013 [1]. Hydropower remains the dominant resource but wind power production is going to increase very fast in all the three scenarios.

Global electricity generation from renewable resources is expected to increase by two and a half times in the *New policies scenario* and as consequence, the share of renewable in the total generation changes from 22% in 2013 to 34% in 2040.

Chapter I

In Figure I.7 it is reported the global renewable-based electricity generation by source of production in the *New policies scenario*, highlighting once again the growing of penetration of wind power plants [1]

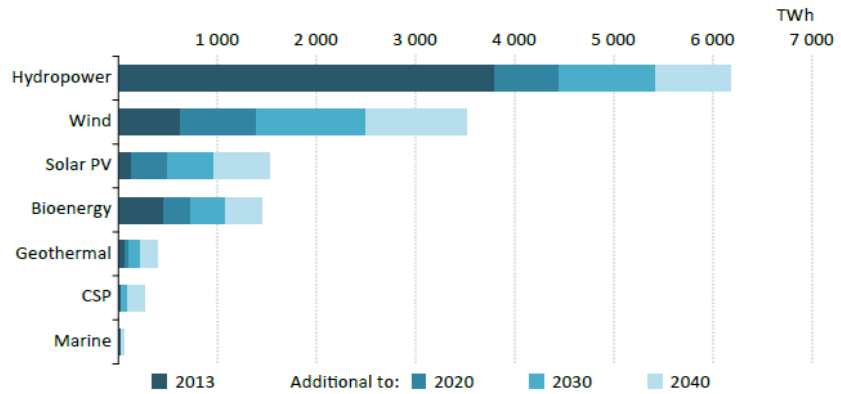

Figure I.7 Global renewables-based electricity generation by technology in the New Policies Scenario [1]

In 2014, the global installed capacity of wind power was 350 GW and they are mainly located in the European Union, China and United States. In particular, European Union steadily increases the annual deployment of wind power with an average of 5% per year [1].

In 2015, renewable power generating capacity saw an estimated 147 GW of capacity added. In particular, solar PV and wind set their record in installation, together making up about 77% of all renewable power capacity added in 2015 [6].

By the end of 2015, renewables covered an estimated 28.9% of the world’s power generating capacity, enough to supply about 23.7% of global electricity consumption (Figure I.8) [6].

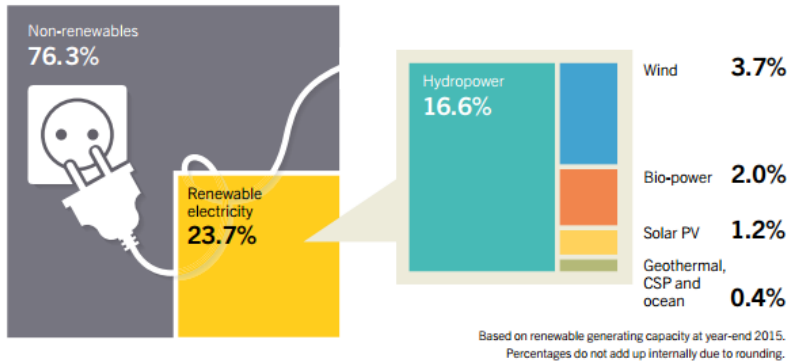

Figure I.8 *Estimated renewable energy share of global electricity production, end-2015 [6]*

In Figure I.9 it is reported the U.S. consumption (quadrillion Btu) of power produced by renewable in 2015 by sectors.

By Sector, 2015

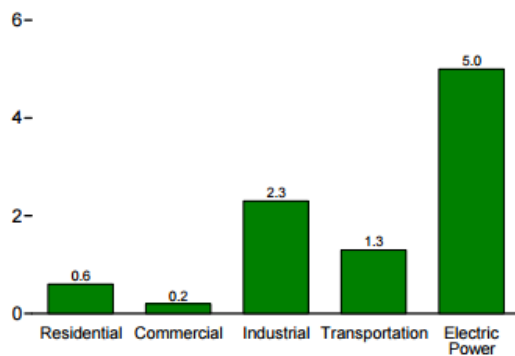

Figure I.9 *U.S. consumption of power produced by renewables [4]*

About solar PV, in 2015 the global solar PV capacity was equal to 227 GW. The European solar PV market is quite varied as shown in Figure I.10 [5], where the division of the typologies of PV installations is made according to the following criteria [5]:

- residential: systems below or equal to 10 kWp;
- commercial: systems with capacity between 10 and 250 kWp;
- industrial: systems with a capacity above 250 kWp;
- utility scale: systems with a capacity above 1000kWp and built on the ground.

It is worth noting that solar PV installation is growing in the residential sector due to the opportunity of self-consumption, price drop and government subsidies. This led the DNOs to face new issues in ensuring the grid technical constraints, such as stronger fluctuation of the net loads,

Chapter I

voltage rise, reverse power flow, flickers as it will be shown in the next chapters [7],[8].

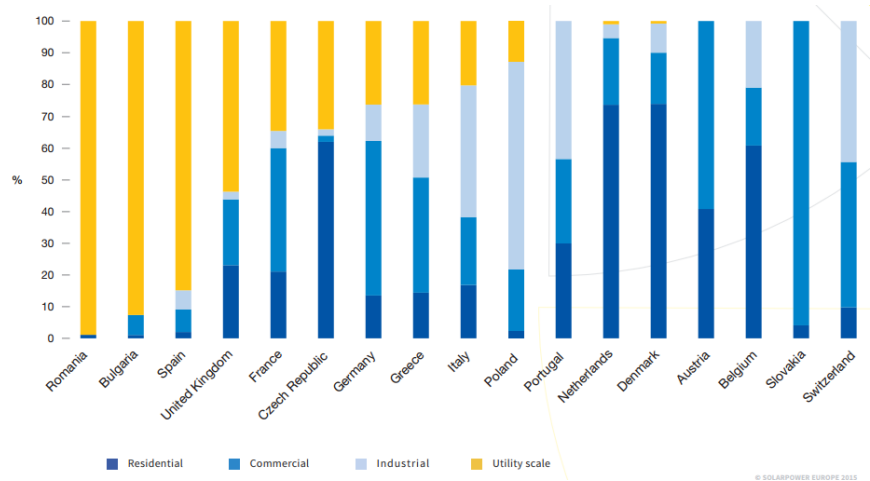

Figure I.10 Typology of PV installation in Europe [5]

In the U.S. residential sector, in particular the distributed solar energy consumption (electricity) amounted to 47 and 65 trillion Btu in 2014 and 2015, respectively. In 2016, from January to September the consumption was equal to 77 trillion Btu, that is about 1.54% more than the consumption recorded on 2015 in the same period [4](Figure I.11).

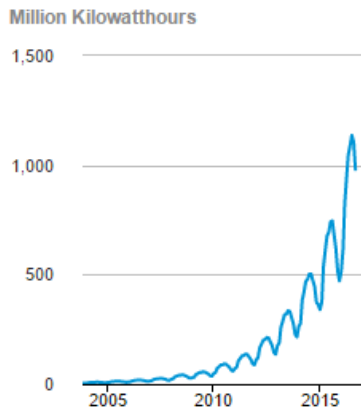

Figure I.11 U.S. residential sector distributed solar energy consumption [4]

I.3 The transition from a centralized to a decentralized electrical power system control

In the last decade, the electrical power system has undergone a radical change due to the introduction of new actors in the energy scenario and the deployment of new technologies in the grid.

In literature, there are many definitions of smart grid in order to describe this concept. One of this is the following one [9]:

A smart grid is an electricity network that uses digital and other advanced technologies to monitor and manage the transport of electricity from all generation sources to meet the varying electricity demands of end-users. Smart grids co-ordinate the needs and capabilities of all generators, grid operators, end-users and electricity market stakeholders to operate all parts of the system as efficiently as possible, minimizing costs and environmental impacts while maximizing system reliability, resilience and stability.

Therefore, a smart grid is the electricity network which includes additional features, e.g. information, communication and technologies to monitor, control and manage the power flows on the grids in order to ensure a safe, resilience and smart management of the grid.

The introduction of smart grids involved the deployment of advanced technological solutions on the grids and as consequence, there was a push in the development of novel solutions.

The transition from a grid to a smart grid is presented in Figure I.12.

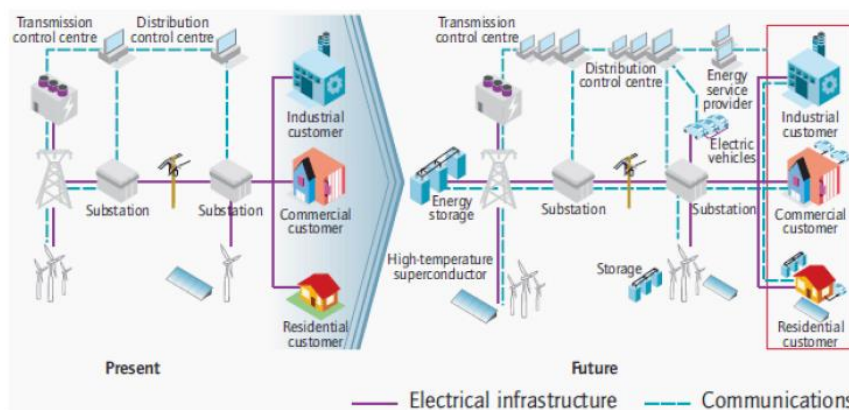

Figure I.12 From grid to smart grid [9]

The main features introduced in smart grids are:

- enabling demand flexibility and prosumers

Chapter I

- integration of distributed energy resources, storage elements and renewable resources in the grid
- improvement of power quality
- optimization of the equilibrium between demand and production using the most efficient supply resources and demand strategies
- facing unplanned outages in real time.

The key feature of smart grids is the deep use of automation technology and smart meters in order to exchange information in real time at different levels and promptly intervention when required.

In Table I.2 [10] the most diffused technologies (hardware and software) in smart grids are reported. The introduction of smart meters and the high level of automatization helped the DNOs to manage the grid in a more resilience way thanks to the new energy actors able to provide services to them.

<i>Technology area (level of maturity)</i>	<i>Hardware</i>	<i>System and software</i>
Wide-area monitoring and control (<i>developing</i>)	Phasor measurement units (PMU) and other sensor equipment	Supervisory control and data acquisition (SCADA), wide-area monitoring systems (WAMS), wide area adaptive protection, control and automation (WAAPCA), wide area situational awareness (WASA)
Information and communication technology integration (<i>mature</i>)	Communication equipment (Power line carrier, WIMAX, LTE, RF mesh network, cellular), routers, relays, switches, gateway, computers (servers)	Enterprise resource planning software (ERP), customer information system (CIS)
Renewable and distributed generation integration (<i>developing</i>)	Power conditioning equipment for bulk power and grid support, communication and control hardware for generation and enabling storage Technology	Energy management system (EMS), distribution management system (DMS), SCADA, geographic Information system (GIS)
Transmission enhancement (<i>mature</i>)	Superconductors, FACTS, HVDC	Network stability analysis, automatic recovery systems
Distribution grid management (<i>developing</i>)	Automated re-closers, switches and capacitors, remote controlled distributed generation and storage, transformer sensors, wire and cable sensors	Geographic information system (GIS), distribution management system (DMS), outage management system (OMS), workforce management system (WMS)
Advanced metering infrastructure (<i>mature</i>)	Smart meters, in-home displays, servers, relays	Meter data management system (MDMS)
EV battery charging infrastructure (<i>developing</i>)	Charging equipment (public and private), batteries, inverters	Energy billing, smart grid-to vehicle charging (G2V) and discharging vehicle-to-grid
Customer-side systems (<i>developing</i>)	Smart appliances, routers, in-home display, building automation systems, thermal accumulators, smart thermostat	Energy dashboards, energy management systems, energy applications for smart phones and tablets

Table I.2 Smart grid technologies [10]

As instance, in Figure I.13 it is reported a residential prosumer [11]. Prosumer is a customer that may be a power consumer or producer and consequentially it is called *prosumer*. It may participate in the energy markets either as active participant or by engaging demand response aggregators. In any case, prosumers influence both the demand and generation side and by the introduction of the new technologies, DNOs can manage them.

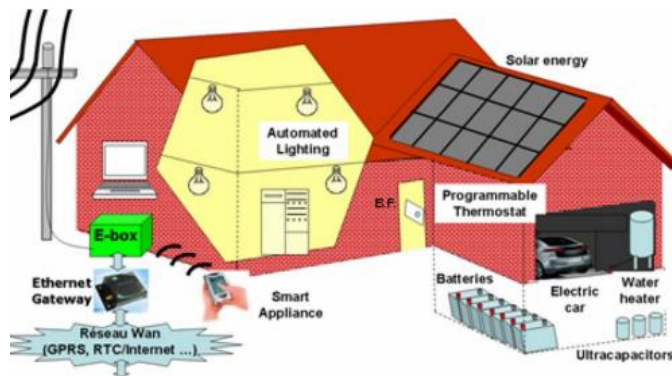

Figure I.13 Prosumer [11]

By the introduction of smart grids a new model of cities was introduced: the smart energy cities presented in Figure I.14.



Figure I.14 Smart city [12]

A complete definition of smart cities is provided in [13] and it is the following one:

Chapter I

The Smart Energy City is highly energy and resource efficient, and is increasingly powered by renewable energy sources; it relies on integrated and resilient resource systems, as well as insight-driven and innovative approaches to strategic planning. The application of information and communication technologies is commonly a means to meet these objectives.

The European Commission [12] describes smart cities as an instrument to obtain energy efficiency in the urbanization and from the energy point of view, it allows the optimal deployment of flexible loads such as electrical vehicles and prosumers, optimal integration of the sustainable urban mobility and distributed energy resources. Smart cities aimed to be a *small-scale* energy blocks since they include generation, demand and regulation modules. A reliable, efficient and resilience smart city is based on a single or *multi-blocks* of microgrids (Figure I.15)[22].

In the recent years, a lot of studies and tests were performed on microgrids in order to prove the effectiveness of their resilience and reliability especially during emergencies, as blackouts or grid instabilities [15].

By using operative strategies, microgrids provide a rapid and effective service to face critical situations, as sudden mismatching between generation and demand, grid faults and so on; in addition, it can isolate itself via utility branch circuits when main grid faults occur.

For this reason, it is essential to have strong energy management strategies in order to ensure the balance between supply and demand during each operating condition and the safety of the power quality constraints.

Flexible resources and robust control techniques help microgrids to run in an efficient and resilience way [14]. In addition, the control and operational strategies in a microgrid can be more bound than those applied in the conventional power systems for the following reasons [14]:

- the generation sources are based on DERs, which have a dynamic and steady state characteristics different from conventional generators;
- microgrids are subjected to a significant degree of imbalance due to high penetration of NP- DERs and single phase loads;
- application of economics strategies to maximize DER power production and demand side management strategies.

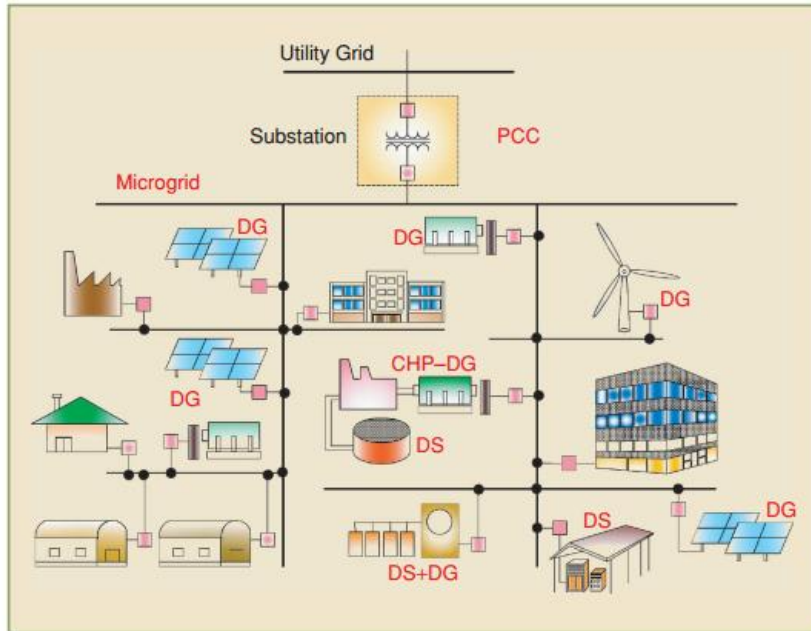

Figure I.15 Typical microgrid structure [14]

I.4 The new role of the distributor operators

As shown before, the increasing penetration of renewable energy resources due to the climate and energy targets set by the Europe 2020 strategy [16] and reinforced by the Paris agreement [17] has led to a deeper utilization of RES (mainly wind and photovoltaics) in the distribution grids. In the recent years, the introduction of smart grids has enabled the technological development in the grids; therefore, DNO has gained a more flexible and detailed control. This allows a boost in network reliability, minimization of energy losses, better integration of DERs and so on. Consequently, DNOs evolved in the new role of distribution system operator (DSO) [18], since it has to manage several sources of flexibility in the network in order to gain a safe control on the grid.

The transition can be summarized in Figure I.16, where in the upper side it is presented the traditional structure of a passive distribution grid managed by DNOs, instead, on the bottom, it is presented DSOs' role that manage the new actors introduced in the energy scenario.

Provided that the DNOs in Europe are characterized by different features, the Council of European Energy Regulators (CEER) in [20] highlighted some key aspects in order to ensure the transition from DNOs to DSOs.

The introduction of DSOs requires coordination between TSOs and DSOs in order to manage the grid holistically and in a cost-effectively and reliable way.

Chapter I

Some key points are reported in [18] and here described:

- in order to avoid inefficiencies, a *whole-system* approach is necessary, especially in network planning and investment, integration of demand-side response and distributed generation, and regulation;
- coordination between DSOs and TSOs in the procurement of system services, operational and network planning/development/investment decisions, and in developing whole system security including cybersecurity;
- the exchange of data in real or close to real time between operators to help coordination and optimization;
- DSOs need to exploit the flexibility offered by decentralized demand and generation resources, via suitable markets;
- fair cost sharing should prevent the risk of creating perverse incentives for DSOs to avoid reinforcement, resulting ultimately in higher costs for customers, and vice versa.

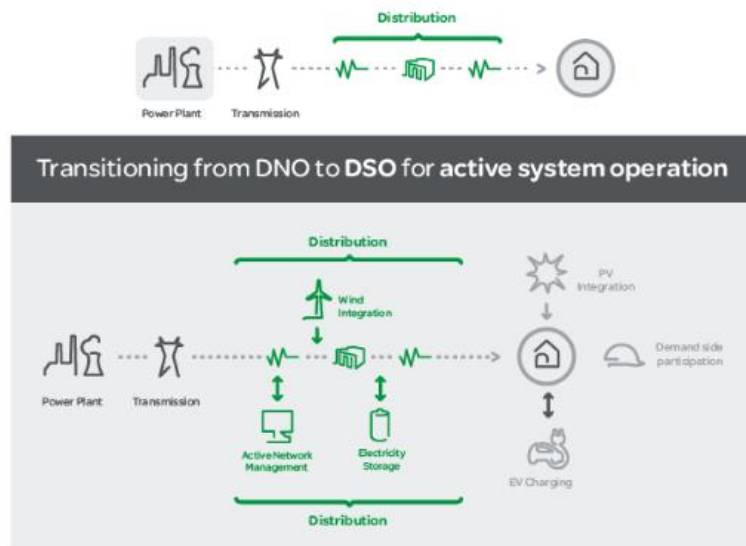

Figure I.16 Transition of DNO to DSO [19]

I.5 The flexibility in power systems

In [21] is reported a general definition of flexibility as “*the capacity to adapt across time, circumstances (foreseeable or not), intention (positive or negative reactions) and area of application*” and the specific definition in the electrical system as “*the possibility of deploying the available resources to respond in an adequate and reliable way to the load and generation variations during time at acceptable costs*” in other words: “*modifying generation and/or consumption patterns in reaction to an external signal*”

(such as a change in price, or an electronic message) to provide a service within the energy system”, while maintaining a resilience, sustainable and affordable electric system” [23].

Due to the targets imposed in reaching a greener energy production, the penetration of PV systems and wind power production is growing with a high rate.

Ofgem in the position paper [23] analyzes the role of flexibility in the future electricity systems. The flexibility can be reached by using demand side response, energy storage and distributed generation.

In order to explain the contribute that flexibility can bring in the management of the grid, the California case study is reported.

California is one of the leading states in the solar installation in USA, therefore it expects over generation problems when the solar power generation is greatest than the electric load. An example is presented in Figure I.17, where it is shown the potential impact of the deep penetration of renewable resources in the grid operations [24].

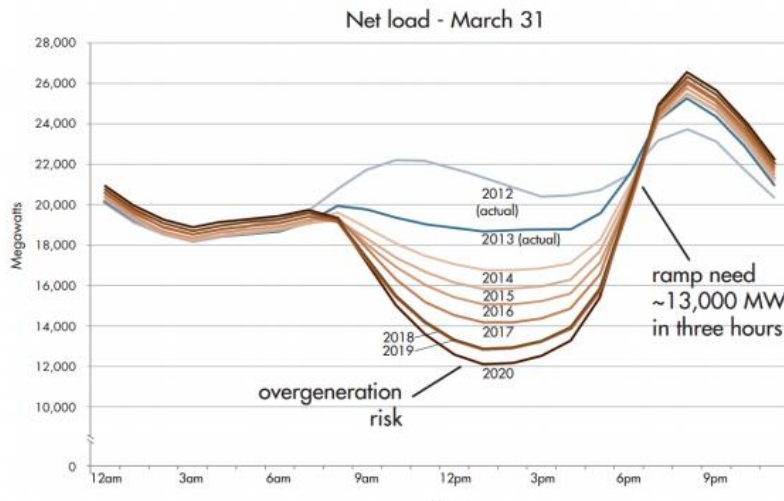

Figure I. 17 CAISO duck curve [25]

In the Figure above, it is presented the *net load* evaluated as difference between the forecasted electric load and the power production from renewable resources (i.e., wind, solar PV and solar thermal) therefore it represents the variable portion of load that CAISO must meet and, consequently, the conventional and controllable power plants should move up and down in order to gain the reliable grid operation equilibrium [25].

It is possible to underline several conditions:

- **steep ramp:** in a short period of time the ISO must bring on or shut down generation resources in order to meet the demand;
- **oversupply risk:** generation is more than the demand;

Chapter I

- **decreased frequency response:** less resources are available to automatically adjust electricity production in order to maintain the reliability in the grid.

Furthermore, the duck chart underlines two critical periods of the day located at the duck neck, i.e. when the solar power production decrease due to the sunset, and at the belly of the duck, when the over generation risk is tangible [26]

The steep ramp issue is a challenge for the grid operator since all the remaining generation resources must quickly meet the demand and therefore, be available on time in order to get the equilibrium. To do that, the ISOs let the suppliers be online and produce at some minimum power output levels even if the electricity is not needed, because most conventional generators are characterized by long start times. In addition, in the generation mix, there are the “*must run*” plants which are needed for local voltage support and reliability issues. As consequence, a “minimum generation” problem arise when the conventional dispatchable generation resources can not be backed down to accommodate the renewable generation [26].

The direct consequence of this situation is the curtailment of the generation from the renewable resources, which can be performed by decreasing the output from wind and PV plants or disconnecting the resources. This type of control is achievable for the medium/large plants, where the system operator has the physical control but it is not available for distributed resources such as rooftop systems [26].

The described conditions led the ISOs to require flexible resources in order to reliably operate on the grids and to optimize the use of renewable resources.

As consequence, the main characteristics of flexible resources include the following functions [25]:

- sustain upward or downward ramp;
- respond for a defined period of time;
- change ramp directions quickly;
- store energy or modify use;
- react quickly and meet expected operating levels;
- start with short notice from a zero or low-electricity operating level;
- start and stop multiple times per day;
- accurately forecast operating capability.

According to the provided overview, a new paradigm is becoming important for the grid operator: *resources flexibility*.

Historically, generators where the only source of flexibility into the grid but with the introduction of the new technologies in the grids new sources of flexibility have been introduced. In Figure I.18 several actors are presented able to provide flexibility to the DSOs.

The lowest cost option are the improved operations and demand response since they can take advantage from the existing infrastructure, making relatively small operational changes. For instance, the first group includes the improvement of weather forecasting and better management of balancing areas [27].

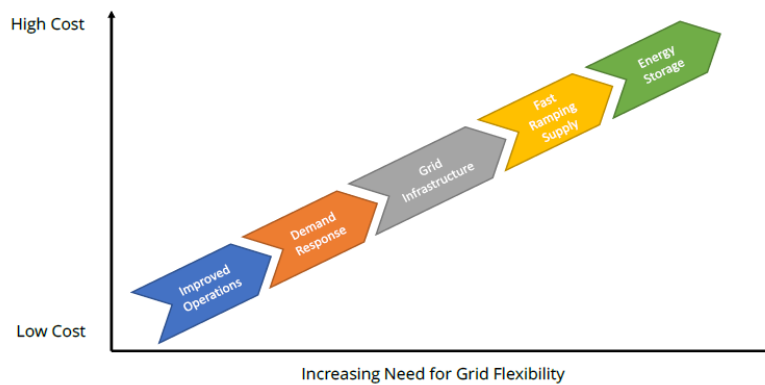

Figure I.18 Flexibility resource supply curve [27]

In this thesis, the demand response option is analyzed.

DSM can provide several ways of flexibility as shown in Figure I.19 and Figure I.20 in order to reduce the need for expensive and not green peaking plants, grid enhancement and so on.

Chapter I

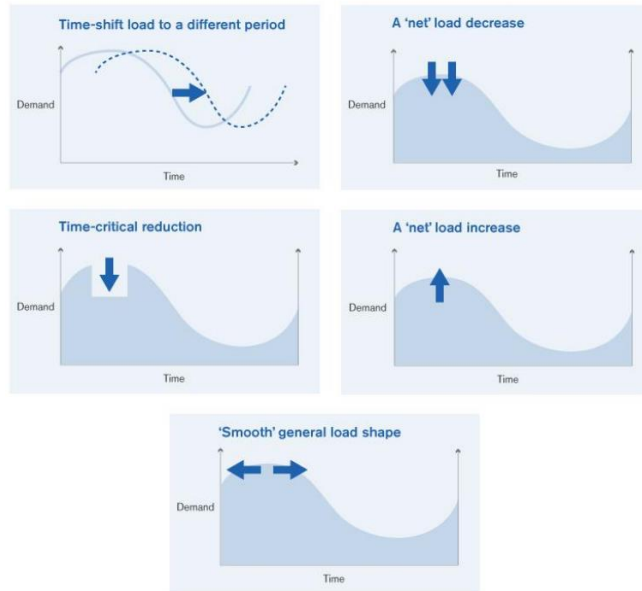

Figure I.19 How demand flexibility can help manage the electricity system [23]

Demand flexibility can be used in critical and ramping period of the day in order to decrease the electrical demand and therefore, decrease the ramp rate. In addition, it can be started and stopped several times since it has not imposed times as generator plants but it depends on the type of contract that the consumers have.

Furthermore, demand flexibility can be used to shift demand when the clean energy is abundant, i.e. in the daytime corresponding to the “belly” of the duck chart, that is the time where the oversupply occurs. This is an advantage both for the grid operator and the costumers since the former can exploit all the energy produced by renewable resources and the latter pay less for their energy [24].

Even if the utilization of DR resources is a good solution to achieve the reduction of the mismatching between generation and demand, there are some drawbacks to consider as the uncertainty associated to the activation and complexity in both modelling the response of DSM resources (there are several factors to consider as weather conditions and customer’s behavior) and coordination of the aggregators of responsive loads [21].

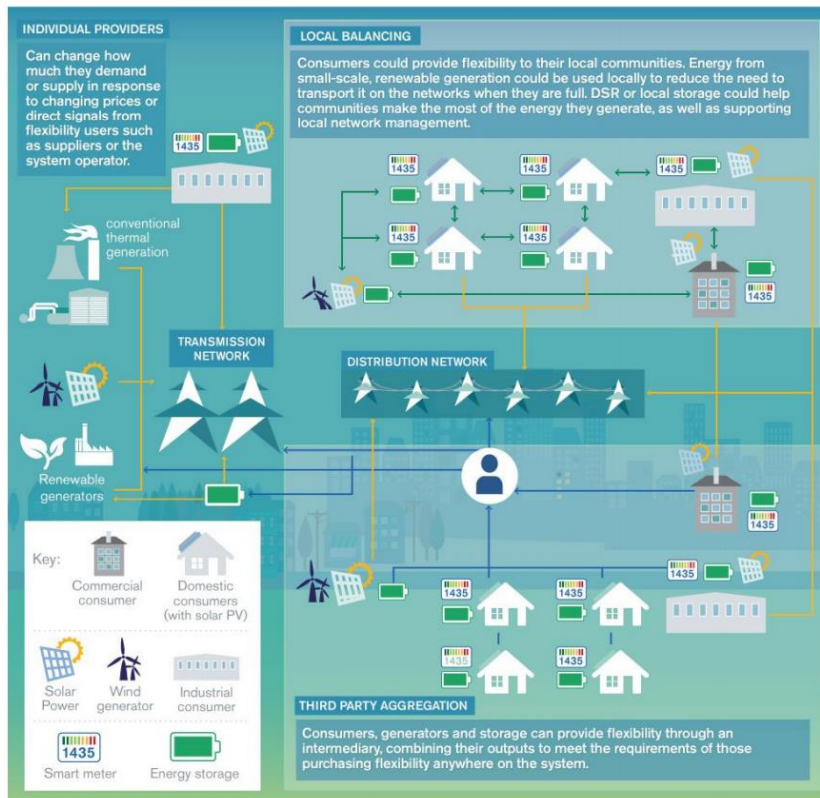

Figure I.20 Demand Flexibility [23]

Summing up, it can be stated that the key challenge in using DR resources is the definition of their flexibility in terms of amount of power and *time of activation*. For the former, it is worth noting that DR activations are evaluated on aggregate loads therefore the cumulative load represents the collective behavior carried out from statistical analysis and when the aggregation level increases, the cumulative load curve is more regular in time since the load diversity between the single consumers are smoothed [21].

I.6 Load flexibility in ancillary services

As introduced previously in the chapter, the volatility due to NP-RES led TSOs to activate balancing actions in order to ensure that demand is equal to supply in the near real time and ensuring that frequency is inside the right range of value.

An important aspect of balancing is the procuring of ancillary services. A good definition of ancillary services is provided by Entsoe in [28] and it is as follows:

Chapter I

“Ancillary services’ refers to a range of functions which TSOs contract so that they can guarantee system security. These include black start capability (the ability to restart a grid following a blackout); frequency response (to maintain system frequency with automatic and very fast responses); fast reserve (which can provide additional energy when needed); the provision of reactive power and various other services. Access to a broad range of services from a wide range of providers, including generators but also demand response (which involves customers changing their operating patterns to aid system balancing) gives TSOs flexible options, which allow them to make efficient decisions.”

Power system operations time frames are mainly presented in Figure I.21, where the main strategies used to ensure the balance between supply and demand are shown. After setting the day scheduling, there are some operations that need to be done in order to meet the real-time load [29]:

- **load following** is the “*action to follow the general trending load pattern within the day*”. Usually, it is executed by the economic dispatch but it can involve the starting and stopping of quick-start turbines or hydro;
- **regulation** balances the second to second/minute to minute load and generation variations. This is done sending control signals to generating units and responsive loads in order to rapidly adjust their dispatching set points.

A more detailed description of ancillary services and regulation (primary secondary, tertiary, spinning and not spinning reserves) can be found in [33]. Indeed, in order to have the operating reserves online, generators cannot run at full load but at part load. This is a cost for both generators and the whole system. For the former, a unit that does not run at full load has a loss of gain and it incurs an *opportunity cost*. For the latter, the generation cost is higher because of keeping supplying units at part load increase the number of generators that must be online and therefore a higher generation cost [30].

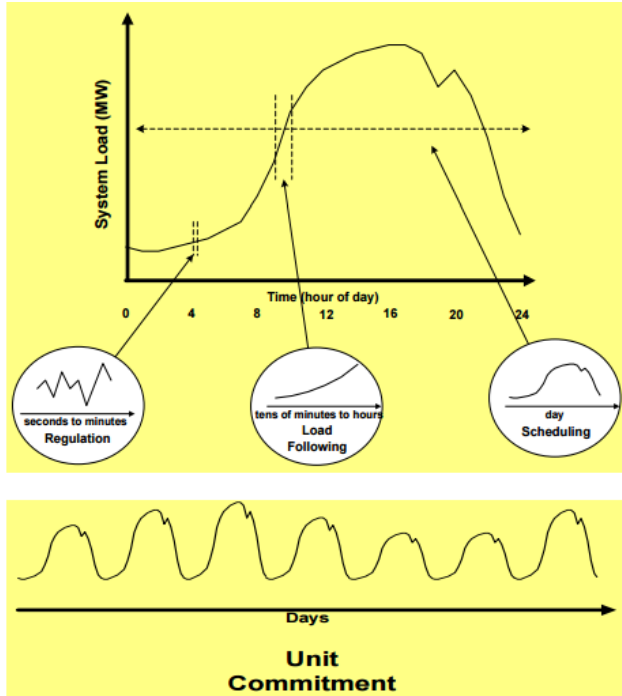

Figure I.21 Regulation services time frames [29]

In [31], the authors present the product definitions for demand response participation in ancillary services markets to improve the not programmable renewable resources integration. They are divided in three products, according to their physical requirements and time of response (Table I.3).

In [32] it is presented a study aimed at presenting the impacts that fast automated DR results could achieve acting as resources in the operational reserves as seen in Table I.3. In details, in Table I.4 are presented the services where DR programs are more suitable to be used and the portion of load that could participate to the selected programs according to the technical (time) constraints presented in the Table I.3.

Chapter I

Product type	General description	How fast to respond	Length of response	Time to fully respond
Regulation (Frequency)	Response to random <i>short term</i> unscheduled deviations in scheduled net load	30 seconds	Energy neutral in 15 minutes	5 minutes
Contingency (Large power plants, line faults)	Rapid and immediate response to a loss in supply	1 minute	<30 minutes	< 10 minutes
Flexibility (service for large wind and solar ramp events)	Additional load following reserve for large unforecasted wind/solar ramps	5 minutes	1 hour	20 minutes

Table I.3 Generalized product definitions for load participation in ancillary services market [31]

Ancillary Services Type	Description	Successful AutoDR Field Pilots and/or meets ISO system requirements?	Portion of total AutoDR Shed Capacity *
Regulation	Maintenance of the minute to minute generation/load balance	Yes	Small
Load Following	Maintenance of the hour to hour generation/load balance	Yes	Medium
Reactive Supply and voltage control	Immediate response to contingencies and frequency	Unlikely **	Unlikely
Frequency Responding (spinning) Reserve	Immediate response to contingencies and frequency deviation	Yes	Small
Supplemental (non-spinning) Reserves	Response to restore generation/load balance within 10 minutes of a generation or transmission contingency	Yes	Large
Future Ancillary Service products designed for AutoDR	AutoDR end-uses with similar characteristics can be aggregated into cost effective portfolios that meet specific grid balancing requirements	NA	Large

Table I.4 Regulation services for DR strategies [32]

It is worth mentioning that the authors report as unlikely the service of DR in the reactive and voltage control because they present a centralized (controlled by TSO) approach but they state that it is possible to apply this kind of service when a local control is implemented [32]]. The column showing evidence of successful DR field, is based on the evaluation of the results obtained in [32].

The definition of the overall flexibility capacity that could be obtained during each time period by loads in the ancillary services (but also energy and capacity markets) is presented in [31] and it is based on the following *load flexibility filters*:

- **sheddability**: the percentage of the total load that has the technical requirements to be eligible to be shed by demand response programs;

Demand Flexibility: the unlocked capacity in smart power system

- **controllability**: percentage of loads equipped with suitable control systems;
- **acceptability**: it is related to the attributes of end-users, as comfort, behavior and so on.

Chapter II

Demand flexibility in the energy markets

II.1 From demand side management to demand response

The Demand side management (DSM) concept was introduced in the 1980s. One of the first definition can be find in [33], where it is reported:

“The planning and implementation of those utility activities designed to influence customer use of electricity in ways that will produce desired changes in the utility’s load shape, i.e. changes in the pattern and magnitude of a utility’s load. Demand-side management encompasses the entire range of management functions associated with directing demand-side activities, including program planning, evaluation, implementation, and monitoring. Opportunities for demand-side management can be found in all customer classes, including residential, commercial, industrial, and wholesale”.

As said, DSM involves both energy efficiency and load management strategies in order to improve the energy system utilization.

By the introduction of competitive markets, the DSM evolution has been demand response (DR) that is the program in which customers reduce their electricity consumption as response to price signals, incentives or emergency signals from the system operator when the system reliability is jeopardized [34].

DR is used by energy retails as mean to maintain the balance between generation and demand for grid operations and the wholesale markets [35]. In Figure II.1. it is reported the scheme of DSM proposed in [36].

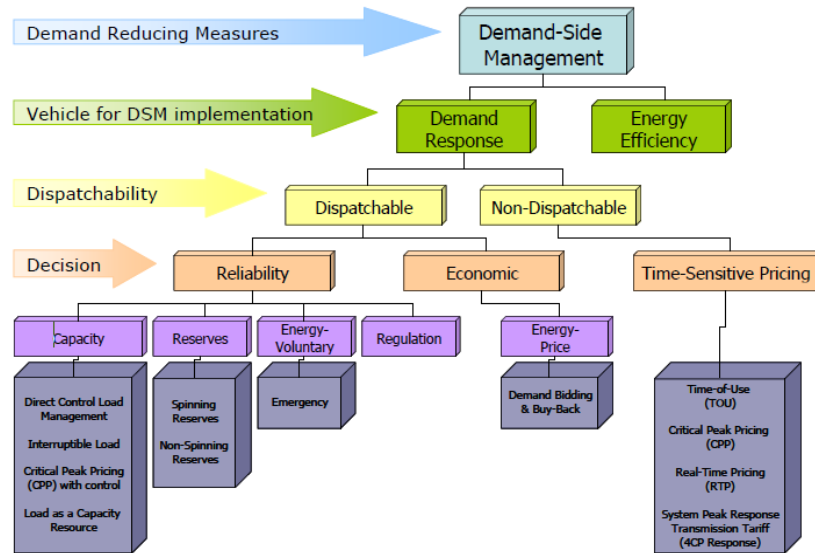

Figure II.1 DSM categories [36]

Here DSM is made up of two main groups: DR and energy efficiency. Energy efficiency can be applied utilizing devices with highest efficiency technologies. It includes programs that seek to support the customers to act in a more efficient way in the electricity utilization.

DR is divided into two groups, non-dispatchable and dispatchable resources [36]. The programs in which DR is involved in capacity and reserve services are not considered in this chapter and some details can be found in [38].

The non dispatchable group is mainly based on the willingness of the end customers to participate. Customers involved receive the real-time retail electricity price and voluntarily decide if shifting, cutting or not acting on their electrical loads according to the level (high or low).

There are several programs included in non dispatchable DR and their collection is called *price-based DR* [37]. It includes the time-of-use rates, real-time pricing and critical peak pricing.

Following, a brief description of the programs included in this set, according to [38]:

- **time-of-use rates** is defined for 24 hours/day and it reflects the average cost of generation and delivery during different blocks of time;
- **real time pricing** changes with the electricity wholesale price and, therefore, it reflects the changes in that market. The customers are notified on a day ahead or hour ahead basis;
- **critical peak pricing** is a hybrid of the previous two programs. It is based on the time of use rates but it replaces the normal peak price with a higher price if specified trigger conditions occur.

The dispatchable DR programs are those involved in the emergency events and economic markets when spike prices occur. The programs are established by utilities, loads-serving entities and transmission system operators [38].

Customers have to respond to their contractual commitments when DR activations are called and in case they don't fulfill, they are subjected to financial penalties [37]. Therefore, DR resources included in this group are considered dispatchable. In these programs, the customer baseline load is specified in order to quantify the demand reduction [37].

The description of the DR programs is reported in [38] and it is as follows:

- **direct load control:** the DR operator remotely shuts down or cycles customers' electrical equipment on short notice. It is mainly offered to residential and small commercial customers;
- **interruptible/curtailable service:** it provides a rate discount or bill credit for agreeing to reduce load during system contingencies. This option is integrated in the retail tariffs and it is stipulated with largest customers;
- **demand bidding/buyback:** the customers offer bids are based on the wholesale electricity market prices or equivalent. The offered curtailment is over 1 MW;
- **emergency demand response:** it provides incentive payments to curtail when reserve shortfalls arise;
- **capacity market programs:** customers offer load curtailments as system capacity as replacement of the conventional generation or delivery resources;
- **ancillary services market:** customers bid load curtailments in ISO/RTO market as operating reserves. They have to be standby if they bid is accepted and if the grid operator call them, they are paid the spot market energy price.

These programs are also defined as *incentive-based* since customers receive incentives as explicit bill credits or payments [38]. As consequence, DR is a competitive resource used in the grids and in the associated wholesale markets to gain the equilibrium between demand and supply. Nowadays, retail customers are unresponsive to wholesale prices, and as consequence when the demand grows, less efficient generators are called to be online; therefore, by reducing the demand during peak periods, the system and the markets can be "greener" [35].

Traditionally, DR programs have been focused on large industrial and commercial customers [39], [40] but with the introduction of aggregators or Curtailment Service Providers (CSP), the retail customers have the opportunity to participate in the wholesale markets.

By the introduction of CSP, residential demand flexibility has become a new actor in the balancing mechanism and in the wholesale energy markets

[41], [42]. DR can be also used as resource on long term capacity market. PJM allowed the participation of DR in this market and it saw overall prices drop by about 85% in 1 year [65].

In the next paragraph, it will be shown how DR can be used in *Day Ahead wholesale energy markets* and in the imbalance mechanism (real-time DR). A summary of DR services is reported in Figure II.2, where ADR means automatic DR.

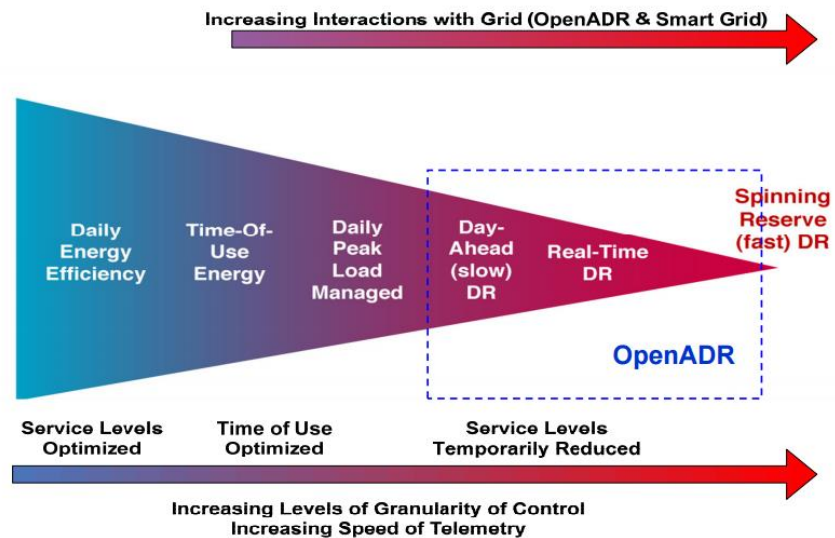

Figure II.2 Representation of DR services and their interaction with grid operator [32]

II.2 DR in the energy markets

II.2.1 Imbalance Mechanism and DR contribute

The growing penetration of renewable energy resources in the power generation has led to an increasing uncertainty in the supply side. An effective solution is the utilization of the DR strategies since they allow shifting the electricity demand in time [43]. The Balancing mechanism has been introduced by the TSOs in order to face the system power imbalances, due to the mismatching between demand and generation. To gain the balance, the TSO establishes BRPs entities at every grid access.

In this paragraph, as representative case, the Belgian grid case is reported.

Each BRP must use all the measures in order to maintain the balance in their perimeters on a quarter-hourly basis [44]. The imbalance in the perimeter is calculated as difference between the total injections and total offtakes (including HUB and Import/Export) [45]. To gain the equilibrium, BRPs can act on the generation side and the demand side. In case of

imbalances, TSO applies imbalance tariffs to activate the power reserves (primary, secondary, tertiary, generation units, adjustable services, sheddable customers, free bids, neighboring system operators) to restore the situation [46]. The imbalance tariffs are paid by the BRPs and they are calculated on the marginal prices for the downward/upward regulations.

As consequence, the BRPs try to achieve two conditions:

- optimization of their portfolio to minimize imbalance costs;
- over supply condition since they can sell their positive imbalance to other BRPs or to the TSO and they will get paid if the system is in a *short* condition.

The source of uncertainty in the BRPs portfolio is mostly due to the introduction of renewable energy resources besides the demand deviation between the actual and predicted values.

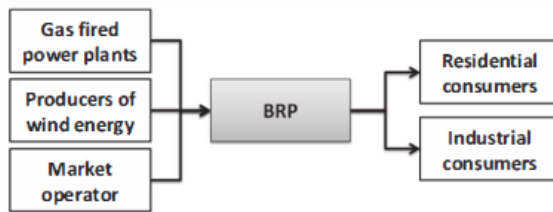

Figure II.3 BRP day ahead schedule [42]

As example, it is reported the Belgian imbalance mechanism.

In Figure II.3 it is presented a schematic about the day ahead operations that the BRPs must set in order to gain the equilibrium between generation and demand. BRPs can buy electricity via the wholesale market, by generators of wind power or the electricity produced by gas-fired power plants and the demand that must be supplied is from both residential and industrial consumers. The day ahead portfolio planning is done on a 15 minutes basis, since it is the minimum time resolution for the balancing mechanism.

In Figure II.4 the different options that BRPs can select in the intraday imbalance mechanism are shown. BRPs decide which solution is the best for the selected time according to technical limitations and costs. They can: modify the flexible generation units that belongs to their portfolio; trade electricity on the intraday wholesale market; activate demand side flexibility; or, at least option, paying the imbalance costs to the TSO [42].

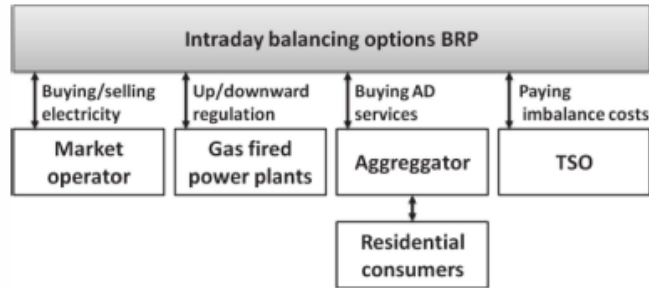

Figure II.4 BRPs intraday options [42]

The introduction of flexible and controllable resources is essential in managing the imbalance and therefore in reducing the imbalance costs. As example, by using DR (applied by industrial consumers or aggregators for small consumers), it is possible to decrease the effects of the uncertainty in the BRP perimeters since it is possible to manage the load flexibility to gain the balance in the portfolio.

II.2.2 Day ahead energy market

In this paragraph, we introduce as reference case the contribute of DR in the U.S wholesale DAM and in the next section a case study will be presented.

In U.S., the Federal Energy Regulatory Commission (FERC) is in charge of overseeing and regulating the wholesale markets run by ISOs and RTOs [47], called here IGOs, that administer the electricity markets within one or multiple regions [48].

In order to make DR an effective actor in the energy markets, FERC introduced the Order No. 719 in which the CSPs are presented as active participant in the market [49] and the Order No. 745 [50] in which it is defined how the CSPs must be paid. In the case study shown later, the Order No. 745 will be described to evaluate the impact on the wholesale electricity prices. One example of the roles of the U.S. DAMs is reported in [51], [52].

The IGOs use a mechanism based on *locational marginal pricing* (LMP) to set the price of energy purchases and sales in the wholesale electricity markets. LMPs represents the cost to serve the next MW of load and it reflects the value of the electricity at the specific location and time it is delivered. It is calculated according to the electricity demand, generation costs and congestions on the transmission system [55](Figure II.5).

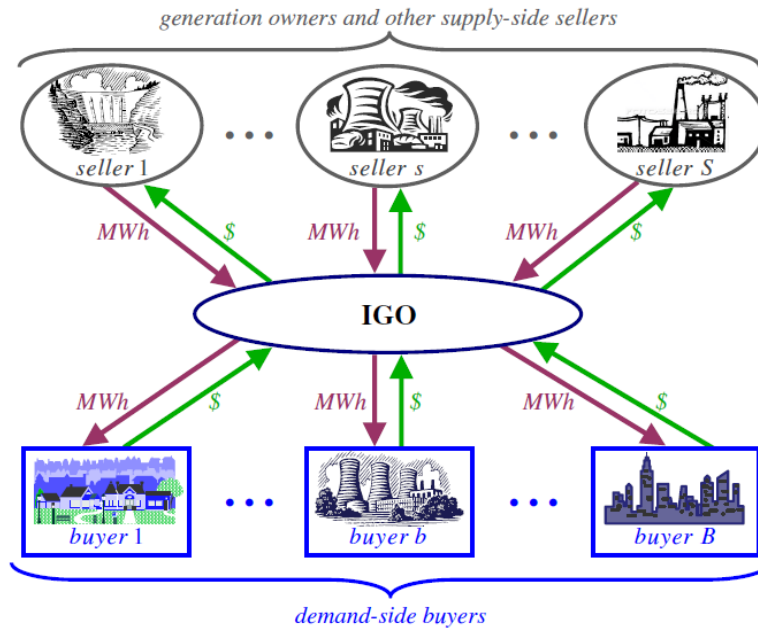

Figure II.5 Wholesale electricity market [55]

Indeed, DR modifies the LMPs and the impacts will be shown later in this chapter. Here a brief overview about the hourly DAM mechanism is reported. Every hour, the IGO constructs the supply and the demand curves according to the sellers' offers and the buyers' bids. The former is also called *aggregate supply curve* since it is evaluated by summing horizontally all the generators' supply curves sorted by increasing prices and the latter is the *aggregate buyers' curves* evaluated by summing and sorting by decreasing prices the buyers' demand bids [54]. In Figure II.6 the market clearing price, the consumer and producer surplus are presented, where P is the price for MWh [\$/MWh] and Q is the market traded quantity [MW] [54]. The market clearing price, that is the locational marginal price (LMP), is identified where the intersection between the two curves occurs, therefore each sellers/buyers that clear the market, sell/buy each MWh at that price. The clearing price is not the same in the whole system but changes locally.

As shown, the *consumer surplus* is defined as difference between the value of the energy purchased at the bid prices and the amount paid to buy the electricity, instead the *producer surplus* is the difference between the revenues received by the seller for the clearing quantity at the clearing price and the prices at its offer prices [55].

From these two relations, it is possible to define the *pool social welfare* as the difference between the total benefits of the buyer and the total costs of the sellers.

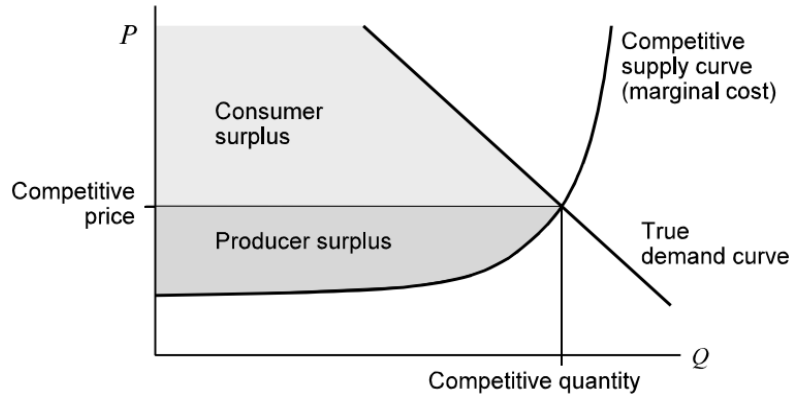

Figure II.6 DAM model [54]

By the introduction of DR, the demand curve shifts on the left since there is a demand reduction, therefore the LMP is reduced from the value P' to P'' .

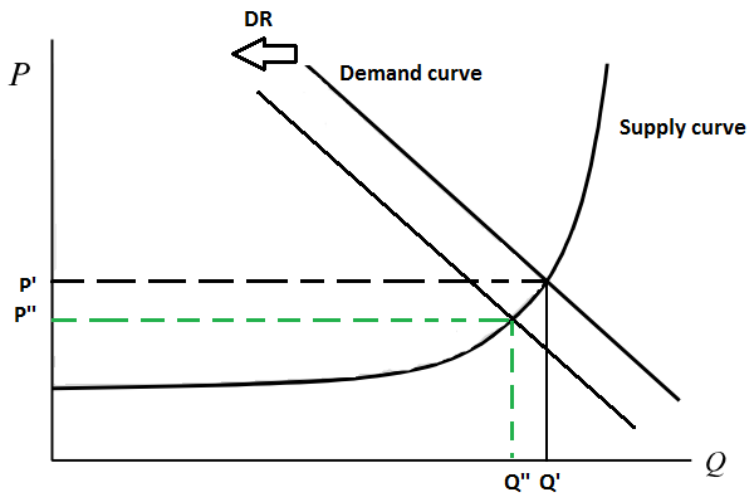

Figure II.7 DAM with DR (Graphic adapted from [54])

DR programs are used also to mitigate or reduce congestion events in the transmission lines. Transmission congestion occurs when overloads in the line or transformer occur, therefore using DR programs in a proper way can help to reduce the number of congestion events [66].

II.3 Impact of demand response resources on power systems in the presence of energy storage and renewable generation.

As it was previously introduced, the application of DR programs makes possible to achieve financial benefits, such as:

- reduction of LMPs and DAM price volatility during the peak hours;

- system advantages, since it avoids the short-term upgrade of the transmission and distribution infrastructure;
- reliability improvement and reduction of carbon dioxide emissions [38].

As said, in DR programs, retail consumers are aggregated into groups called CSPs which offer to cut the electrical loads during emergency conditions (emergency DR programs) and/or when the wholesale prices are high (economic DR programs)[35]. DR programs are well-established opportunities for various retail consumers to be active participants in the electricity markets.

As case study, it is reported the impact of DRRs involved in the U.S. Independent System Operator (ISO)/ Regional Transmission Organization (RTO) day ahead electricity markets (DAMs).

Later on, CSPs are called DRRs and the case study analyzes the DRRs involved in the economic programs. Several papers focus on the utilization of DR in the DAMs, a selection of those are [56]-[59] that evaluate the impact of DR on the LMPs, energy production costs and emissions.

The study focuses on the long term (one year long) impacts of DRRs which are evaluated using a stochastic simulation approach in order to pinpoint the effects on the reliability and economic metrics, e.g. expected unserved energy, loss of load probability, wholesale purchase prices, CO₂ emissions and LMPs considering the utilization of DRRs and energy storage systems (ESSs).

It is considered a lossless transmission system network composed by L lines and $N+1$ nodes and the set of sellers is called S and the set of buyers B . During the DR activations, the buyers are divided in two non-overlapping subsets: the simple buyers \bar{B} , and the set of DRRs \tilde{B} , where $\tilde{B} \cup \bar{B} \equiv B$, $\tilde{B} \cap \bar{B} \equiv \emptyset$. The set of ESSs belongs to the set $E = \{e : 1, 2, \dots, E\}$, and the wind power plants are referred as S_w , with $S_w \subset S$.

The DRRs and the ESSs act either as loads and generators, depending on the specified period of the week and the day. The one-year study period T is divided into T_i one week long simulation periods which in turn are composed by 168 indecomposable sub-periods T_h (hours). Over each T_h , the system configuration, the market structure and the seasonality effects are set. It is used an extended DC optimal power flow (DC-OPF) transmission-constrained DAM clearing model (EMCM) with the introduction of ESSs and DRRs decision variables and constraints. The objective function to be maximized over the set of hours during the day k , $h \in H_k$ is the system social welfare, evaluated as difference between the total social benefits and the total supply cost functions. Therefore, the problem formulation is:

Chapter II

$$\max \sum_{h \in H_k} \left[\sum_{\bar{b} \in \bar{B}} \beta^{\bar{b}}(p^{\bar{b}}[h]) + \sum_{\tilde{b} \in \tilde{B}} \beta^{\tilde{b}}(p^{\tilde{b}}[h]) + \sum_{\tilde{b} \in \tilde{B}} \beta^{\tilde{b}}(p^{\tilde{b}}[h]) - \sum_{s \in S} \gamma^s(g^s[h]) - \sum_{s^w \in S^w} \gamma^{s^w}[h](g^{s^w}[h]) \right] \quad (\text{II.1})$$

s.t.

$$\left(\underline{p}^s[h] + \underline{p}^w[h] \right) - \left(\underline{p}^{\bar{d}}[h] + \underline{p}^{\tilde{d}}[h] \right) + \underline{p}^e[h] = \underline{B} \vartheta[h] \quad (\text{II.2})$$

$$\left(\underline{p}_0^s[h] + \underline{p}_0^w[h] \right) - \left(\underline{p}_0^{\bar{d}}[h] + \underline{p}_0^{\tilde{d}}[h] \right) + \underline{p}_0^e[h] = \underline{b}_0 \vartheta[h] \quad (\text{II.3})$$

$$\varepsilon^e[h] = \varepsilon[h-1] + \frac{1}{\eta_g^e[h]} - \eta_l^e l^e[h] \quad (\text{II.4})$$

$$\left(\kappa_g^e \right)^m .u_g^e[h] \leq g^e[h] \leq \left(\kappa_g^e \right)^M .u_g^e[h] \quad (\text{II.5})$$

$$\left(\kappa_l^e \right)^m .u_l^e[h] \leq l^e[h] \leq \left(\kappa_l^e \right)^M .u_l^e[h] \quad (\text{II.6})$$

$$0 \leq u_g^e[h] + u_l^e[h] \leq 1, u_g^e[h] \in \{0,1\}, u_l^e[h] \in \{0,1\} \quad (\text{II.7})$$

$$\left(\varepsilon^e \right)^m \leq \varepsilon^e[h] \leq \left(\varepsilon^e \right)^M \quad (\text{II.8})$$

$$p_m^s[h] \leq p^s[h] \leq p_M^s[h] \quad (\text{II.9})$$

$$p_m^b[h] \leq p^b[h] \leq p_M^b[h] \quad (\text{II.10})$$

$$\underline{f}^m[h] \leq f[h] \leq \underline{f}^M[h] \quad (\text{II.11})$$

$$\left(c^{\tilde{b}} \right)^m .u^c[h] \leq c^{\tilde{b}}[h] \leq \left(c^{\tilde{b}} \right)^M .u^{cl}[h] \quad (\text{II.12})$$

$$\sum_{h \in H_k^r} r^{\tilde{b}}[h] = \iota \cdot \sum_{h \in H_{k-1}^c} c^{\tilde{b}}[h] \quad (\text{II.13})$$

$$\left(r^{\tilde{b}} \right)^m \cdot u^r[h] \leq r^{\tilde{b}}[h] \leq \left(r^{\tilde{b}} \right)^M \cdot u^r[h] \quad (\text{II.14})$$

$$0 \leq u^c[h] + u^r[h] \leq 1, u^c[h] \in \{0,1\}, u^r[h] \in \{0,1\} \quad (\text{II.15})$$

$$\forall h \in H_k, \forall b \in B, \forall \tilde{b} \in \tilde{B}, \forall s \in S, \forall \varepsilon \in \Sigma$$

where $p^s[h][MWh/h]$ is the scheduled output of seller s , $p^b[h][MWh/h]$ is the scheduled consumption of buyer b , $p^{\tilde{b}}[h][MWh/h]$ is the scheduled consumption of buyer \tilde{b} , $\gamma^s(p^s[h])$ represents the integral of seller s 's marginal offer price, function of $p^s[h]$, $\beta^b(p^b[h])$ is the integral of buyer b 's marginal bid price, function of $p^b[h]$, $\beta^{\tilde{b}}(p^{\tilde{b}}[h])$ is the integral of buyer \tilde{b} 's marginal bid price, $p_e^e[h][MWh/h]$ is the net power injection of storage resources. ESSs are modeled as MW week scale ISO system resources [61]; as pumped-hydro storage, compressed-air energy storage and some battery technologies (sodium sulfur and flow battery)[64] and in this paper $g^e[h][MW]$ and $l^e[h][MW]$ are the discharging output and the charging load of ESS e , $u_g^e[h], u_l^e[h]$ are the binary variables that specify the operational states of the ESS e , $(\kappa_g^e)^m, (\kappa_l^e)^m$ are the minimum discharge and charge capacity for ESS e , $(\kappa_g^e)^M, (\kappa_l^e)^M$ are the maximum discharge and charge capacity for ESS e , $\eta_g^e[h], \eta_l^e[h]$ are the discharge and charge efficiency of ESS e , $(\varepsilon^e)^m, (\varepsilon^e)^M$ are the minimum and maximum stored energy limits for ESS e .

Chapter II

Furthermore, $\theta[h]$ is the vector nodal voltage angles, $p_m^s[h](p_m^b[h]), p_M^s[h](p_M^b[h])$, are the lower and upper bounds for $p^s[h], p^b[h], \underline{f}^M[h], \underline{f}^m[h]$ are the upper and lower bounds of the line flow vector $\underline{f}[h] = \underline{B}_d \Delta \theta[h]$, $\underline{B} \in R^{N \times N}$ is the nodal susceptance matrix, b_0 denotes the slack bus nodal susceptance vector $\left(b_0 = [b_0^1, \dots, b_0^N]^T \in R^N \right)$.

Defined $p_n^{\bar{d}}[h] = \sum_{\substack{b \in \bar{B} \\ \text{at node } n}} p^b[h]$ the sum of withdrawals of the simple buyer during the DR activation at node n , $p_n^{\tilde{d}}[h] = \sum_{\substack{\tilde{b} \in \tilde{B} \\ \text{at node } n}} p^{\tilde{b}}[h]$ the sum of withdrawals of the DRRs at node n , and $p_n^s[h] = \sum_{\substack{s \in S \\ \text{at node } n}} p^s[h]$ the sum of

injections at node n and:

$$\begin{aligned} \underline{p}^{\bar{d}}[h] &= \left[p_1^{\bar{d}}[h], p_2^{\bar{d}}[h], \dots, p_N^{\bar{d}}[h] \right]^T \in R^N, \\ \underline{p}^{\tilde{d}}[h] &= \left[p_1^{\tilde{d}}[h], p_2^{\tilde{d}}[h], \dots, p_N^{\tilde{d}}[h] \right]^T \in R^N \\ \underline{p}^s[h] &= \left[p_1^s[h], p_2^s[h], \dots, p_N^s[h] \right]^T \in R^N \end{aligned} \quad (\text{II.16})$$

the vectors of \bar{B} 's and \tilde{B} 's withdrawals and S 's injections $\forall n \in N \setminus 0$. Furthermore, $c_n[h]$ and H_k^c are the curtailed load and curtailment set of hours during day k and $r_n[h]$ and H_k^r the recovered load and set of hours for buyer \tilde{b} at node n and α and ι are the penetration percentages of DR and the percentages of load recovered by DRRs, respectively. In addition, the routine optimizes the amount of DRRs' energy recovered during the selected hours with the wind power production. This assumption is made in accordance with the idea that DR can introduce a deeper utilization of the wind power plants production, that is advantageous either for consumers [56] and wind power producers [60]. The simulation approach is based on the stochastic method, in particular on Monte Carlo simulation technique and on the extension presented in [61] based on the multi-period scheduling optimization problem (SOP) in order to consider the inter-temporal coupling introduced by the ESSs model. The representation for the

wind power output is drawn from the stochastic model of the multi-site hourly wind speeds presented in [62].

Starting from [61], the DR constraints regarding the maximum amount of power curtailment and recovery are introduced, and DRRs are subjected to FERC Order No.745 [50], which affects DRRs utilization and DRRs costs allocation. For the former, there is a cost-effectiveness condition at full LMP for the load curtailment provided, if the nodal LMP during hour h is greater than the system-wide threshold price determined every month by the ISOs. For the latter, the Order establishes that the cost for the load curtailment has to be proportionally allocated to all the entities that act in the relevant energy market in area(s) where the commitment or dispatch of DRRs lead to the reduction of energy market price at that hour [50]. Indeed, the Order affects the calculation of DRR benefits, buyer payments and LMPs.

Called the pre-curtailment LMP at node n , $\lambda_n[h]$, the post curtailment LMP at node n , $\hat{\lambda}_n[h]$ and the monthly system threshold price $\lambda^t[m]$, where m is the selected month, the subset of nodes in which the conditions specified in [50] are met, that is $\lambda_n[h] > \lambda^t[m]$ and $\hat{\lambda}_n[h] > \lambda_n[h]$, is called $\hat{N}[h]$ and the buyers belonging to this set have to pay the additional charge $v_n[h]$ (\$/MWh) to compensate the DR curtailments during hour h . According to the Order, $v_n[h]$ is calculated for each node n as follow:

$$v_n[h] = \begin{cases} \frac{\sum_{n \in N} [c_n^{\tilde{b}}[h]][\lambda_n[h]]^*}{\sum_{n \in \hat{N}[h]} [p_n^b[h]]^*} & \text{if } n \in \hat{N}[h] \\ \frac{\sum_{n \in N} [c_n^{\tilde{b}}[h]][\lambda_n[h]]^*}{\sum_{n \in N} [p_n^b[h]]^*} & \text{if } \hat{N}[h] = \phi \end{cases} \quad (\text{II.17})$$

Therefore, the presence of DR, the total buyer payments changes from:

$$\rho^B[h] = \sum_{n \in N} \left(\left[p_n^d[h] \right]^* - \left[c_n^{\tilde{B}}[h] \right]^* \right) \left(\left[\lambda_n[h] \right]^* \right) \quad (\text{II.18})$$

to

$$\rho^B[h] = \sum_{n \in N} \left(\left[p_n^d[h] \right]^* - \left[c_n^{\tilde{B}}[h] \right]^* \right) \left(\left[\lambda_n[h] \right]^* + v_n[h] \right) \quad (\text{II.19})$$

In order to determine the clearing wholesale market price points, each

Chapter II

ISO constructs the supply and demand curves sorting the sellers and buyers offers/bids as increasing/decreasing prices, respectively. The introduction of DRRs implies a left shifting of the demand curve causing a clearing wholesale market point down-shifting [38]. Since generators base their wholesale prices bids on the marginal production costs (i.e. fuel), we consider that the costs for DRRs are near zero since fuel is not involved in the injection of one MWh/h supplied by DRRs. Therefore, whenever the threshold condition is met and the DRRs are available at hour h , they cut an hourly percentage of their load and DR costs are evaluated after the optimization routine.

II.4 Case Studies

Simulations are performed on the modified *WECC 240 bus system* [63]. During each simulation period, the EMCM is run in order to solve the unit commitment and guarantee a 15% reserve margin over each period T_i . To evaluate the impacts of DRRs, the DR penetration and DR intensity parameters are used. It is performed an analysis based on the variation of DR penetration from 5% to 15% with steps equal to 5%, in the presence of wind generation and ESSs. For each penetration level, it is set the DR intensity and the DR recovery percentage equals to 0%, 50%, 100%, of the curtailed nodal load of the previous day.

In order to modulate the number of hours in which DR curtailment occurs, the intensity parameter is introduced and it allows to set the number of hours that are used over the curtailment interval.

Therefore, the number of curtailment hours during day k can be 2 (low intensity), 4 (medium low intensity), 8 (medium intensity) and 10 (high intensity). Even if the number of curtailment hours is set, the selection of the curtailment hours is different between the nodes in order to have a more realistic representation.

The weekday is made up of three hourly intervals in which the DR activations can be realized: *recovery interval* from 1 a.m. to 6 a.m., *curtailment interval* from 10 a.m. to 10 p.m. and *idle interval* from 7 a.m. to 9 a.m. and from 11 p.m. to 12 a.m. In the case study it is supposed that there is not DR activity during the weekends. The number of DRRs is equal to 20% and 100% of the total system nodes. On the generation side, it is considered a system wind nameplate capacity of 10200 MW, uniformly divided among 4 wind farms. In addition, there are 5 ESSs with *round trip efficiencies* equal to 0.9, capacities equal to 200 MW and 400 MW and storage capabilities equal to 2000 MWh and 4000 MWh, respectively [61].

The analysis is performed during one-year period. As in [61], the results are averaged over all the representative weeks of the year so that they can be plotted over an average week of the year.

II.5 Representative results

The first presented results are evaluated with high DR intensity and all the buyers in the grid are DRRs.

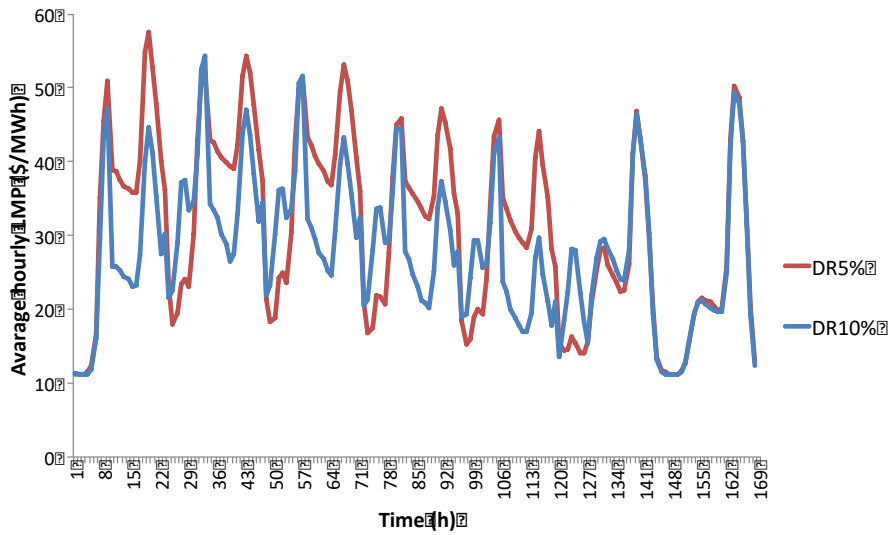

Figure II.8 Hourly average LMP

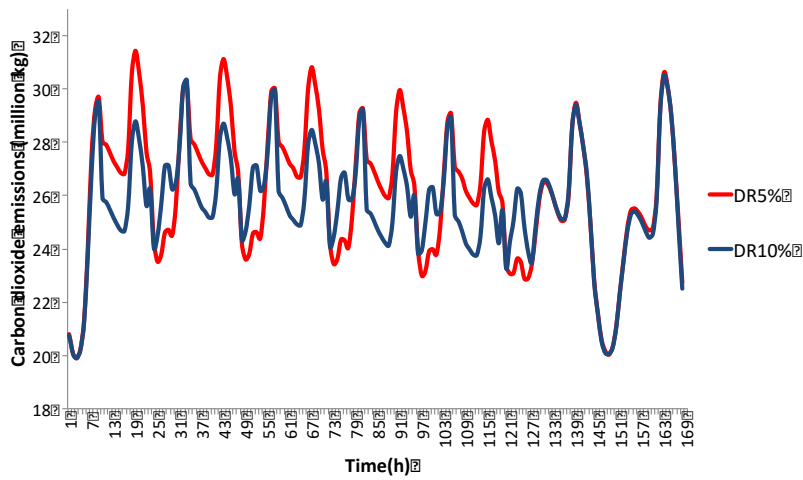

Figure II.9 CO₂ emissions

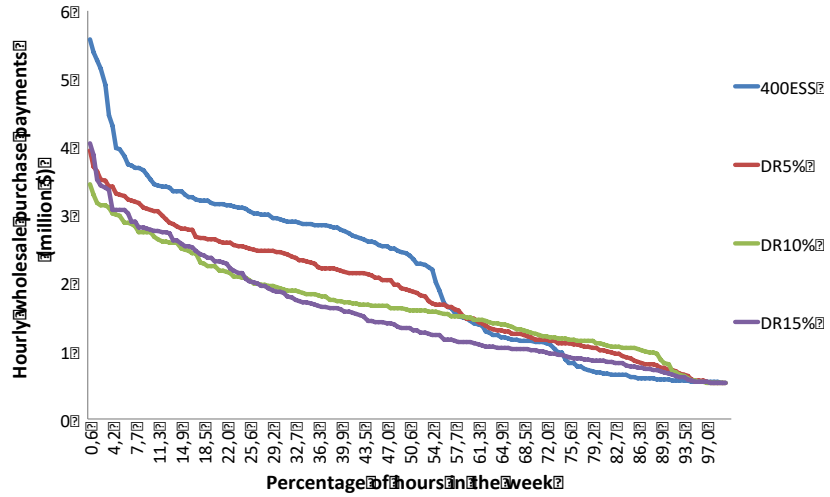

Figure II.10 Hourly purchase payment duration curves

In Figure II.8, it is shown the hourly nodal average LMP evaluated with DR percentage penetration equal to 5% (red line) and 10% (blue line), DR energy recovery equals to 50% and ESS capacity equal to 200 MW. The LMP curve decreases during the daily hours and increases during the night hours due to the change of the load pattern. This effect is more significant increasing the DR penetration percentage due to the energy recovery factor.

In Figure II.9, the CO₂ system emissions profiles are reported. Due to the DR energy recovery, which produces the night peak demands, the benefits of DR in the reduction of emissions are decreased, in fact the transition from DR 5% to DR 10% leads to a reduction of emissions equal to -1.68% compared with the case without recovery (-3.42%).

In the second case study, the DR penetration varies from 5% to 15%, setting the DR recovery equal to 50% and the ESS capacity equal to 400 MW. The hourly purchase payment duration curves (Figure II.10) with DR 5% (red line) and DR 10% (green line) is for the 57% of the weekly hours less than the purchase payments with the only utilization of ESSs. Using DR penetration equal to 15% (purple line) the purchase payments are greater than DR 10% for around the 25% of the time due to the night recovery and the additional purchase prices due to the DR curtailment.

The reliability metrics are reported in Figure II.11 and Figure II.12. The Expected Unserved Energy (EUE) and the Loss of Load Probability (LOLP) decrease moving from DR 5% to DR 10% but with DR 15%, the performances get worse since the high amount of energy recovery causes the inversion of the ESSs cycles, therefore, the ESSs and DRRs recoveries occur during the day and night, respectively.

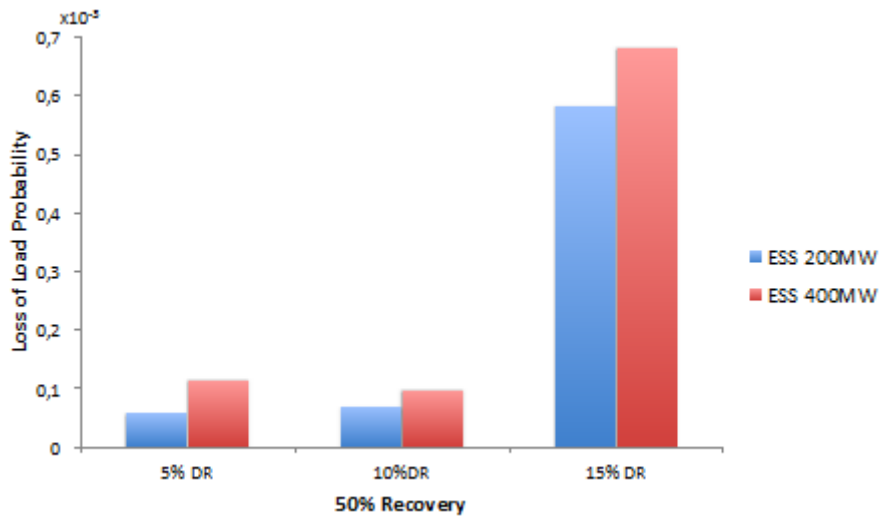

Figure II.11 *LOLP*

Following, the number of DRRs is set equal to 20% of the total grid nodes and the intensity, penetration and recovery parameters vary in the ranges specified in each case study.

The ESS capacity is equal to 200 MW if not specified. In order to have clear labels to represent the case studies, it is introduced the following format: in the first place, there is the information of the ESS capacity in the system, after it is reported the DR penetration percentage, the number of DR nodes in the grid and finally the intensity.

Figure II.13 shows the variation of LMP in percentage compared to the case without the DR activity. It is possible to note that although the recovery percentage increases, DR allows to reduce the LMP since the recovery in the model is optimized with the wind power production in the grid and, in addition, the low percentage of DR nodes allows to smooth the negative effects of the recovery shown before.

Chapter II

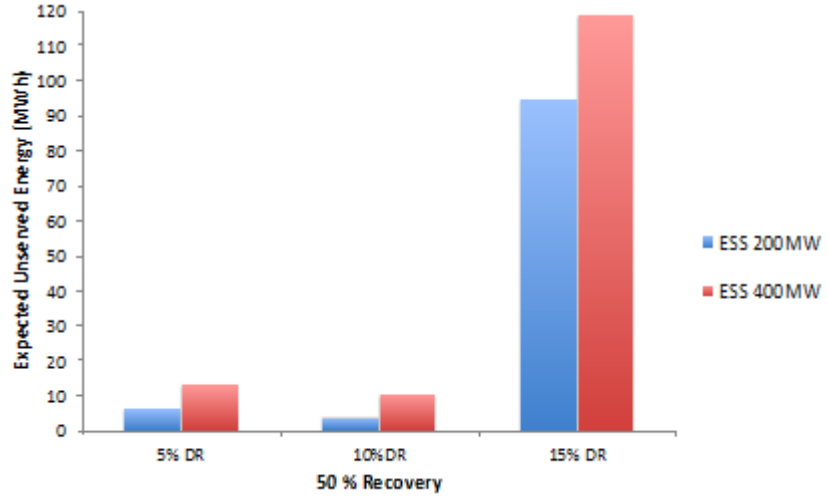
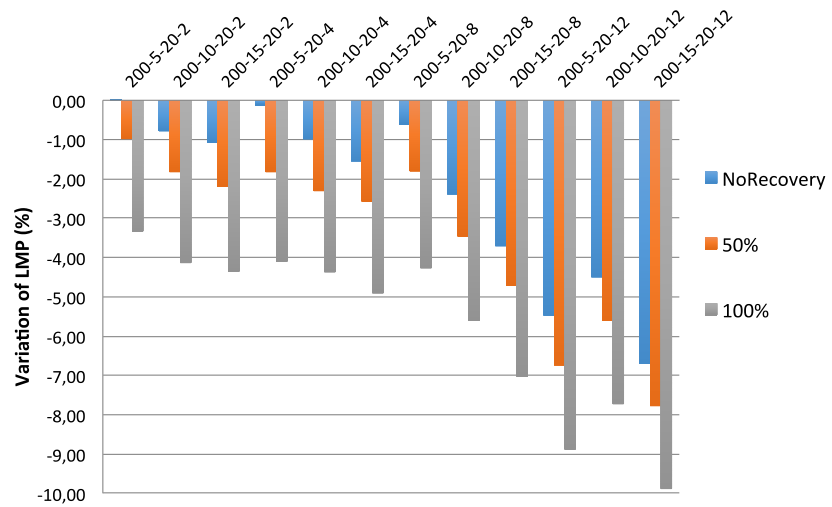

Figure II.12 EUE



FigurII.13 Variation of LMP

In Figure II.14 it is presented the yearly average over all the DR nodes of the additional charge $v[h]$ for the case studies reported in the figure. The Figure II.15 and Figure II.16 shows the variation of the EUE and LOLP in percentage compared to the case without DR.

Compared to the case study, in which all the nodes are DRRs, it is possible to see that there is not a predictable behavior, especially when the DR penetration percentage is very low. The effect of the wind generation used for the recovery is also very significant in these results.

Demand Flexibility: the unlocked capacity in smart power system

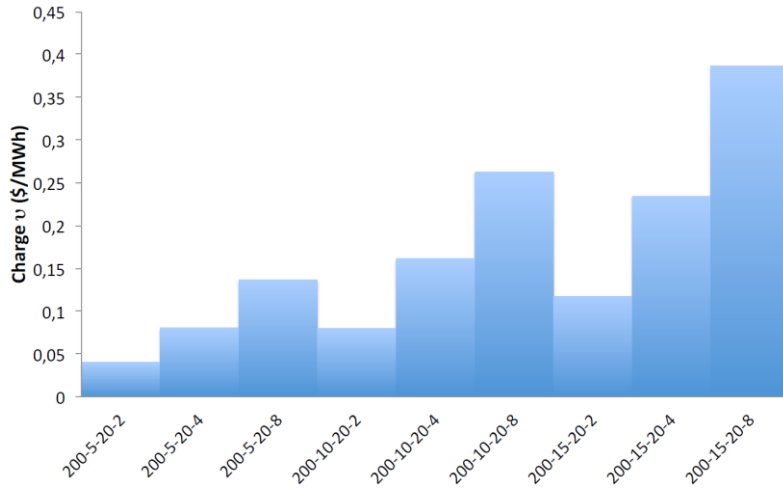

Figure II.14 Charge $v[h]$ (\$/MWh)

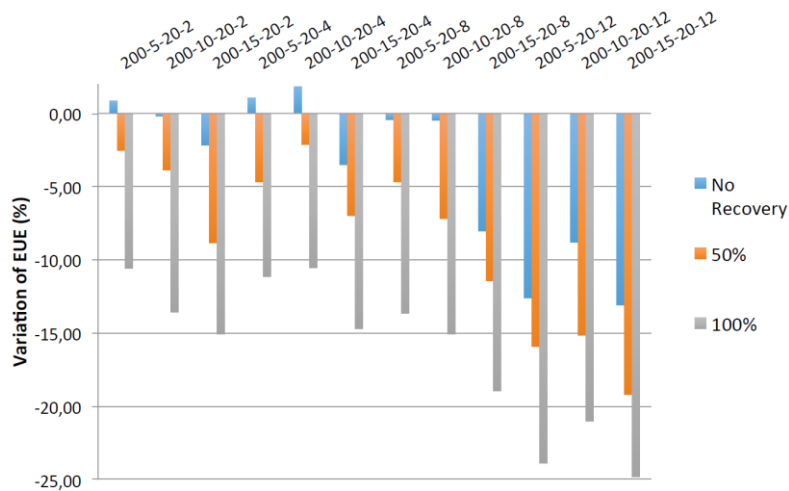

Figure II.15 Variation percentage of EUE

In Figure II.17 it is possible to note that the CO₂ emissions in the scenario without recovery decrease up to 2% compared to the base case, however, the CO₂ emissions in the grid grow with the increasing of recovery percentages.

Finally, DRRs together with an increase of ESSs capacity helps in reducing the yearly average LMP of the network, as shown in Figure II.18.

Chapter II

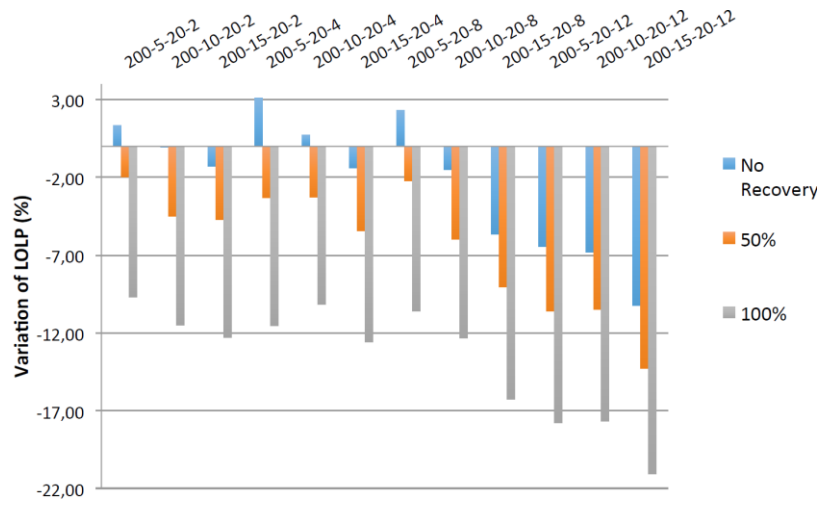

Figure II.16 Variation percentage of LOLP

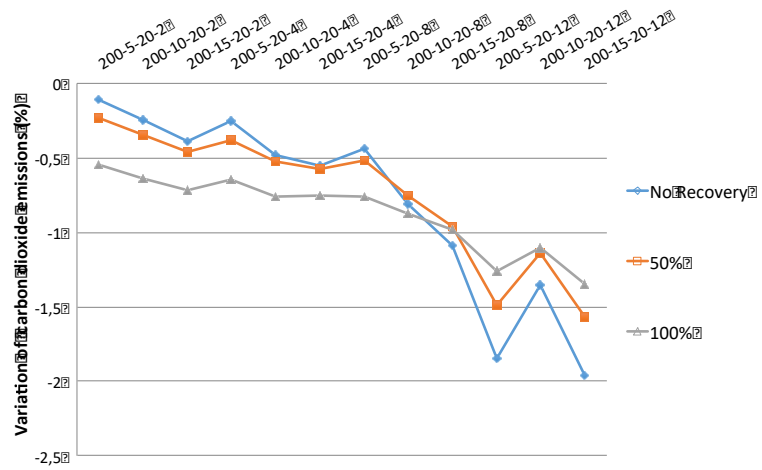

Figure II.17 Variation percentage of CO₂ emissions

Demand Flexibility: the unlocked capacity in smart power system

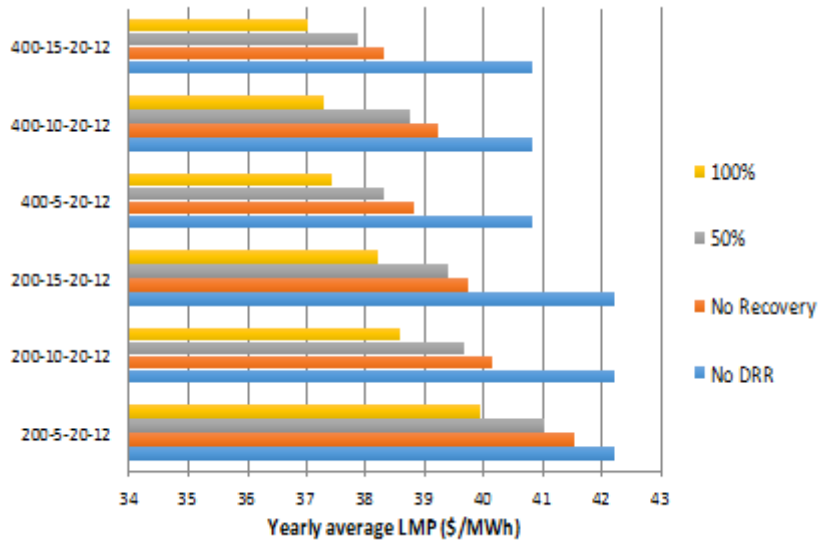

Figure II.18 Yearly LMP average

Chapter III

Demand modulation in distribution grids

III.1 DSO challenges in distribution grids

In the next years, an increasing electricity consumption in residential areas is expected, also due to the deeper penetration of electric vehicles and heat pumps.

Nowadays, the random nature of electricity demand in the residential sector has the effect that typically the maximum grid load in LV distribution grids is only 25% of the sum of the individual maximum loads due to the *load diversity* [67]. By the introduction of electric vehicles and heat pumps, the randomness is smoothed because of the similar behavior of end users in using them. DSM strategies are going to further reduce the end users random behavior because they are going to shift the electrical loads when the energy price is very low or even negative. All these new actors introduce the “*loss of load diversity*” and therefore higher electrical demand flowing in the cables is expected.

As consequence, DSOs are going to face congestion issues due to overloading on distribution grids [67].

In distribution grids, the term *congestion* refers to the condition when active power demand exceeds the capability of the grid [68].

It may equally occur on medium and low voltage grids and it can be related to the cables or the transformers. It mostly depends by the history of the grids (if there were enhancement or not) therefore it is not possible to say whether it occurs more often on MV or LV networks.

Traditionally, congestions have been solved by expanding the capacity of the grid, e.g. new cables, larger transformers or by modifying the topology of the grid [67] but this is relatively expensive.

Chapter III

Another challenge for DSOs is the management of the increasing number of DERs in LV grids.

DERs could cause voltage rises in networks, especially when there are periods of low demand, reverse power flows and as seen before, ramp issues. Therefore, a deeper penetration of them implies the need of a deeper grid control for DSOs. All these issues led DSOs to apply new strategies and technologies to maintain the voltage regulation and power quality in the grids.

To enhance flexibility in LV grids and mitigate the issues presented, European DSOs are considering the use of *on load tap changer* distribution transformer (OLTC) in LV distribution grids. Traditionally, this type of networks was equipped with *off load tap changers* but they do not provide a flexible voltage control since the transformer ratio can only be changed when the load is disconnected. For this reason, OLTC-fitted distribution transformers help DSO to achieve a flexible control specially in residential scale PV systems as shown in [69]-[74]. An example of use of OLTC can be found in [75].

In addition, the introduction of OLTC-fitted LV distribution transformers let to extend the voltage regulation range in LV distribution grids since it compensates the voltage fluctuations that occur on MV grids and the voltage drop within the MV/LV distribution transformer. As example, let us think that in some utilities, voltage drops in MV grids varies between 2 and 5%. If we consider that voltage drop on secondary distribution transformer is around 1%, the maximum allowed voltage drop in LV distribution grid is at most between 7% and 4% of the nominal value. By the introduction of OLTC transformer it is possible to use all the voltage regulation range in LV grids that is $\pm 10\%$ since it “decouples” MV grid from LV grid [69].

OLTC is mostly studied for enhance the integration of distributed energy resources. For example, in [76] several voltage control options are considered in order to maintain the voltages inside the standard limits and as consequence, to increase the network capacity in installing DERs. In particular, the authors analyze the effect of OLTC distribution transformer, capacitor banks and storages elements on the feeders in order to define the most effective solution. In [74] the authors present a techno-economic assessment about the potential benefits of using OLTC transformers in LV distribution grids versus grid reinforcements in order to increase the grid hosting capacity for PV penetration. In the following paragraphs, it will be presented the application of OLTC distribution transformer on MV and LV grids to mitigate peak load events.

III.2 Power reduction approaches in distribution grids

Scientific and technical researches are investigating the opportunity to face the expected growing of electrical demand in distribution grids by managing it. In details, in recent years the attention has been focused on the

utilization of residential and small commercial demand flexibility to disclose their potential in the provision of services for real time optimal power flows (such as balancing) and integration of distributed resources.

As introduced previously, one of the target of demand flexibility is the reduction of activation of generation reserves which represent a significant cost for the system. As it is well known, *peak power* plants are activated when peak load conditions occur, therefore their cost is high due to underutilization since they are online few hours per year, compared with the base and intermediate load power plants (Figure III.1) [77].

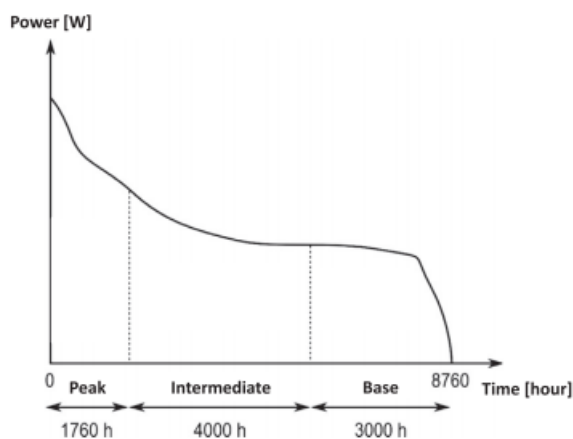

Figure III.1 Load duration curve for generators [77]

An approach based on the deployment of economics DR programs in distribution grids is presented in the ADDRESS European project (Active Distribution networks with full integration of Demand and distributed energy RESources), which aimed at defining the role of active demand in the small commercial and residential sectors in order to minimize the use of peak load generation units and allow a better integration of distributed renewable energy resources [78]. In this project, end users are active participant in the electricity distribution process and they are able to adjust their consumption according to real time pricing by means of Load Aggregators and the use of smart meters and devices [79].

Another important project aimed at exploiting the potential of residential loads is called “Customers Load Active System Services” (CLASS) run by the England DSO Electricity North West Limited (ENWL) [80]. It is based on a different approach since it allows the demand modulation in an indirect way, that is to say, customers are not involved in economics DR programs but their loads are modified by means of technological solutions developed for DSOs in order to manage the end users power consumption by using the relationship between power and voltages.

As it will be shown later, the project modulates the power consumption in MV distribution grids using OLTCs and dynamic voltage regulation. The

Chapter III

results achieved by the project were that customers did not notify any effects on their electricity supply and for what concerns the power modulation, the results are reported in Table III.1 [80]. Indeed, power modulation aims both at reducing and boosting the voltages over the feeders but in this thesis, it will be analyzed the effect of voltage reduction.

Name of CLASS service	Action	Effect	Time to effect onset	Effect duration	Measurement	Effect size per unit	Overall effect size (ENWL)	Overall effect size (GB)
Demand reduction (System balancing)	Tap down on request	Active power reduction	20-120s	Extended period	Recorded at each substation with the results aggregated to show overall response. Response determined as difference between demand prior to and post response.	Up to 5% local voltage reduction (7% demand reduction) in response to NETSO request	94-271MW (summer min - winter max) for a 5% voltage reduction	1.2-3.3GW (summer min - winter max) for a 5% voltage reduction
Demand boost (System balancing)	Tap up on request	Active power increase	20-120s	Extended period	Recorded at each substation with the results aggregated to show overall response. Response determined as difference between demand prior to and post response.	Up to 5% local voltage increase (7% demand increase) in response to NETSO request	57-163MW (summer min - winter max) for a 3% voltage increase	0.7-2GW (summer min - winter max) for a 3% voltage increase

Table III.1 Reserve type CLASS service [80]

In CLASS it is used Conservation Voltage Reduction (CVR) technique as means to reduce the voltages across the feeders. CVR was introduced in the 70's [68] and from that moment onwards it became an established technique adopted by utilities to manage peak demand, losses and introduction of energy savings in the electrical distribution systems. CVR technique is based on the idea that by lowering voltages on the feeders in a controlled manner it is possible to manage the power on the grid.

The CVR effects can be evaluated by using the CVR factor defined as:

$$CVR_{factor} = \frac{\Delta E_{\%}}{\Delta V_{\%}}$$

where $\Delta E_{\%}$ and $\Delta V_{\%}$ represent the percentage of energy and voltage reduction, respectively. When CVR is applied to achieve energy savings and, therefore, it is activated for long time, it is called *long term CVR* instead when it aims at demand reduction in selected time intervals it is called *short term CVR*, as shown in Figure III.2 [81].

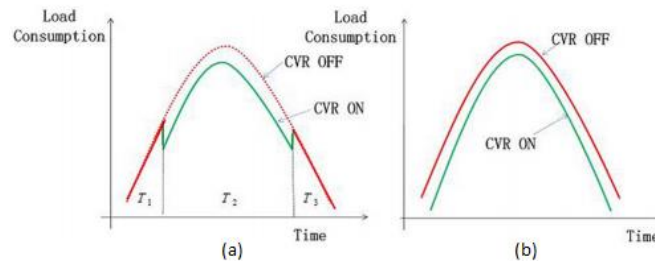

Figure III.2 CVR long and short term power reduction [81]

Another benefit in the application of CVR is the overall reduction of system losses. By applying this technique, the distribution transformers expect a core, eddy current and hysteresis losses reduction [81]. For what concern the line losses, they may locally increase if the local demand behaves as a constant power load (the meaning will be described later in this chapter) and therefore the lines losses may increase. According to [82], the overall effect of CVR is a net system losses reduction when the transformer losses are taken into account and line losses increase slightly (around 0.1 percent).

As said, typically primary substations are equipped with automatic voltage control systems to regulate the system voltages, therefore the CVR tests presented in literature are carried out on the primary substations.

In particular, it is worth reporting the study presented in [83] included in the project CLASS, shown before. The project aims to define a first assessment of the potential response in UK primary substations (33/11 or 33/6.6 kV). In particular, the project provides to DSOs a deeper understanding about the opportunity to use residential consumers to “unlock” their aggregate demand response in an indirect way, e.g. without directly managing them but exploiting the relationship between voltage and power that will be shown later. The project highlights the advantage for DSOs in using this solution in terms of investment deferral by peak demand reduction (as consequence decongest the distribution network) and as reserve for the TSOs in order to face the variability due to renewable resources. The studied presented in [83] are executed on a winter day on 349 primary substations and they show that for a 3% of voltage reduction could be possible to achieve an aggregate peak reduction exceeding 150 MW. As shown in Figure III.3 they shown that about 37% of the primary substation considered could achieve a peak reduction about 0.35 and 0.50 MW.

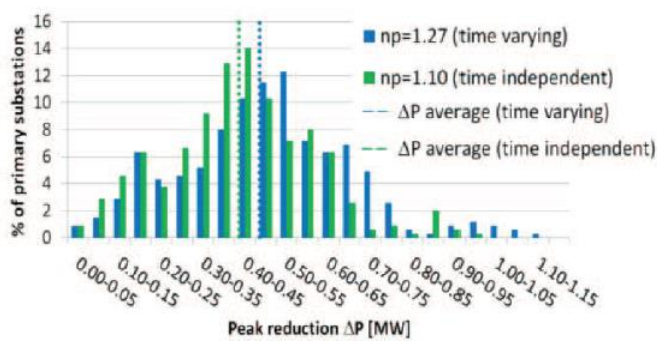

Figure III.3 Primary substation peak power reduction [83]

Another interesting study is presented in [84], where a CVR impact study is presented. The authors did the simulation studies on 24 U.S. prototypical

Chapter III

distribution feeders [85] and they presented, among the other results, the peak demand change as percent of the total feeders' load.

It is interesting to note that for 22 over 24 feeders, the application of CVR has a reduction effect on the peak load. The feeder experiencing the 5% of increment is described as a long and rural feeder. This is due to the model the authors used to simulate CVR, since it manages the shunt capacitors on the lines to improve the power factor at the substation and it applies a voltage optimization (reduction/boosting) over the feeders based on the measurements on the end of line points (Figure III.4).

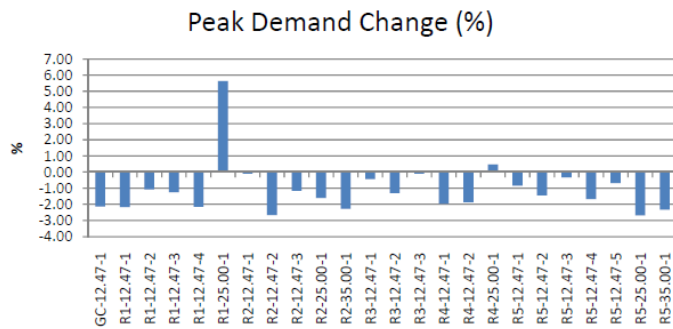

Figure III.4 Peak demand change in prototypal feeders [84]

Since the feeder is characterized by a low voltage profile at the end of the line, the application of CVR begins to regulate and the voltages raise on the feeder during the peak load resulting as a higher peak demand.

Indeed, the results and the advantages in using CVR depend on the composition of the electrical loads of the feeders, the season and so on, therefore it is really hard to obtain general results. According to a study of Navigant Research [86], the CVR pilot projects in United States have achieved good results, therefore they expect that CVR will be used among the North America utilities as a measure to apply demand response.

A most recent study has been executed in [87], where it is evaluated the impact of CVR on a UK LV test grid when residential loads are considered.

The CVR is applied on the distribution transformer equipped with an offload tap changer ranging between $\pm 5\%$. In order to carry out the results, the LV distribution transformer works at nominal voltage and $- 5\%$. The results are very promising since they obtain on the field that the overall grid consumption declined around 6% for a 5% of voltage reduction.

By using a OLTC distribution transformer in LV grids, voltage regulation can be automatized and therefore it is possible to achieve an optimal system operation control.

III.3 Model of residential electrical demand

III.3.1 Electrical active and reactive power demand

In order to represent the residential electrical demand, the model developed by the University of Loughborough is used. In [88] a detailed description is reported and in this thesis, a summary is presented in order to provide an overview.

By using [88], it is possible to simulate the load configuration in residential dwellings by activating the household devices according to their probability to be *ON* and *OFF* during a selected hour of the day.

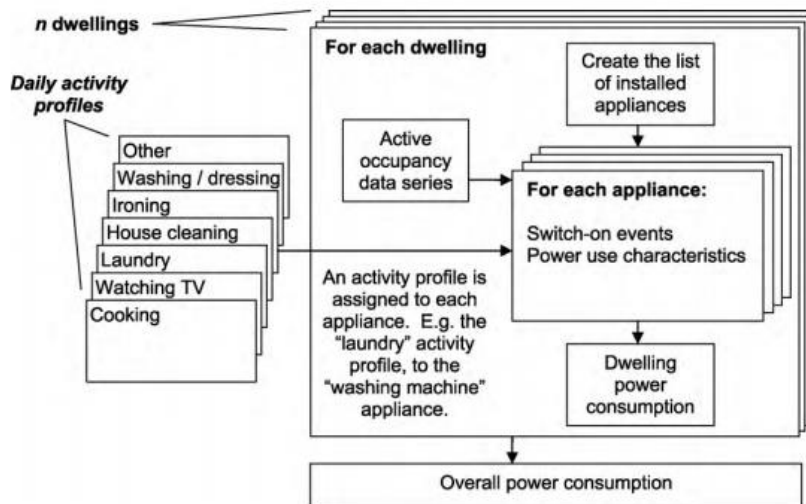

Figure III.5 Dwelling load definition [88]

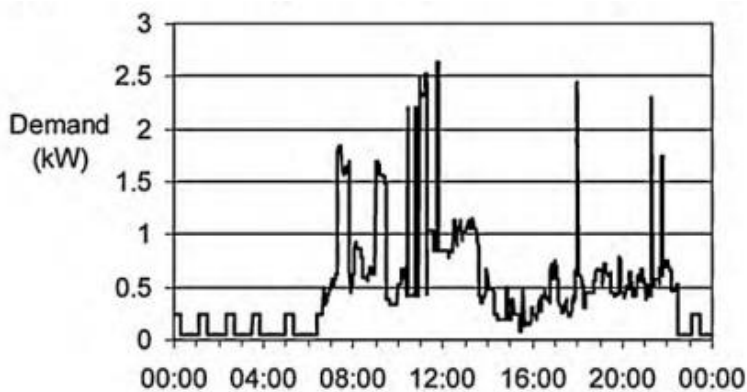

Figure III.6 Dwelling active power demand [88]

Chapter III

In particular, in Figure III.5 it is presented the structure of the model. The daily activity profiles represent the likelihood that people perform the list of activities during different times of the day. Each dwelling is characterized by active occupancy data series, which set the number of people and how many of them share the use of the devices, and a selection of installed household appliances. Each appliance is linked to the corresponding daily activity profile and, when the device is switched on, the *power use characteristics* is used in order to determine its electricity active and reactive power demand. Summing all the power demands of all the activated appliances within a dwelling it is possible to get the cumulative power demand for each dwelling as shown in Figure III.6.

III.3.2 ZIP coefficients model

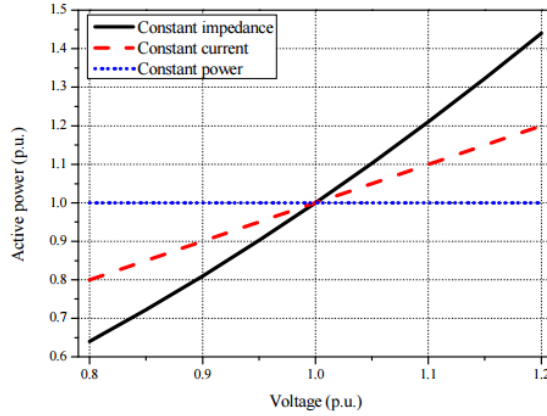

Figure III.7 Active power vs voltage [91]

The ZIP coefficients model define the polynomial relationship between power (active and reactive) consumption of loads and the variation of voltage by using a composition of three types of coefficients, e.g. constant impedance Z , constant current I , and constant power loads P which show the behavior of the load changing the supplied voltage.

The expressions for active and reactive power are as follow:

$$P = P_o \left[Z_p \left(\frac{V_i}{V_o} \right)^2 + I_p \frac{V_i}{V_o} + P_p \right] \quad (\text{III.1})$$

$$Q = Q_o \left[Z_q \left(\frac{V_i}{V_o} \right)^2 + I_q \frac{V_i}{V_o} + P_q \right] \quad (\text{III.2})$$

$$Z_p + I_p + P_p = 1 \quad (\text{III.3})$$

$$Z_q + I_q + P_q = 1 \quad (\text{III.4})$$

where P and Q are the active and reactive power at the operating voltage V_i , P_0 (Q_0) is the active (reactive) power at the rated voltage V_0 , and $Z_{P/Q}$, $I_{P/Q}$ and $P_{P/Q}$ are the ZIP coefficients for the constant impedance, current and power, respectively, subjected to (III.3) and (III.4) [89]. Obviously, if a load is characterized by a $Z_{P/Q}$ or $I_{P/Q}$ or $P_{P/Q}$ coefficient equal to 1, it means that it is a pure constant impedance, constant current or constant power load. In particular, **constant impedance** load is characterized by a quadratic relationship between power and voltage. Space and water heaters (without thermal control) has a typical resistive response. A **constant current** load is characterized by a linear relationship between voltage and power. Finally, a **constant power** load is insensible to voltage variation and it is typical for electronic devices [90]. In Figure III.7 the power/voltage curves for the three typologies of loads are presented [91] and in Figure III.8 the current/voltage curves are shown; it is important to note that a constant power load is characterized by a higher current adsorption when there is a voltage reduction in contrast with the other two loads.

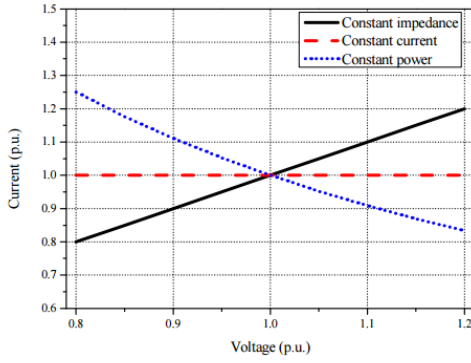

Figure III.8 Current vs voltage [91]

In reality, loads behave as a combination of the three coefficients and they show their own power/voltage dependency. In Table III.2, the ZIP coefficients for the most used household devices are reported where V_{cut} represent the minimum voltage for which the device stops to work [89].

Summing all the ZIP coefficients of the devices inside a selected dwelling, we obtain the whole *dwelling ZIP coefficients* using an approach based on that presented in [92] and reported in the following formula.

$$P_{house} = P_0 \left[Z_P \left(\frac{V_i}{V_0} \right)^2 + I_P \frac{V_i}{V_0} + P_P \right] \quad (III.5)$$

$$Q_{house} = Q_0 \left[Z_Q \left(\frac{V_i}{V_0} \right)^2 + I_Q \frac{V_i}{V_0} + P_Q \right] \quad (III.6)$$

Chapter III

$$P_0 = \sum_{i=1}^{N_{load}} P_{nom_i} \quad (III.7)$$

$$Q_0 = \sum_{i=1}^{N_{load}} Q_{nom_i} \quad (III.8)$$

$$Z_{P_{tot}} + I_{P_{tot}} + P_{P_{tot}} = 1 \quad (III.9)$$

$$Z_{Q_{tot}} + I_{Q_{tot}} + P_{Q_{tot}} = 1 \quad (III.10)$$

$$\left\{ \begin{array}{l} Z_{P/Q_{tot}} = \frac{\sum_{i=1}^{N_{load}} (P_{nom_i} Z_{P/Q_i})}{P_0} \\ I_{P/Q_{tot}} = \frac{\sum_{i=1}^{N_{load}} (P_{nom_i} I_{P/Q_i})}{P_0} \\ P_{P/Q_{tot}} = \frac{\sum_{i=1}^{N_{load}} (P_{nom_i} P_{P/Q_i})}{P_0} \end{array} \right. \quad (III.11)$$

where P_{nom_i} and Q_{nom_i} represent the nominal active and reactive power of the household device i , N_{Load} is the number of household devices in the dwelling and Z_{P/Q_i} , I_{P/Q_i} , P_{P/Q_i} are the constant impedance, current and power coefficients of device i , respectively.

Demand Flexibility: the unlocked capacity in smart power system

Equipment/ component	No. tested	V_{cut}	V_o	P_o	Q_o	Z_p	I_p	P_p	Z_q	I_q	P_q
Air compressor 1 Ph	1	25	120	1109.01	487.08	0.73	0.38	-0.11	0.45	0.51	0.04
Air compressor 3 Ph	1	79	208	1168.54	844.71	1.16	-1.81	1.65	3.58	-5.25	2.67
Air conditioner	2	75	120	496.33	125.94	1.6	-2.69	2.09	12.53	-21.11	9.58
CFL bulb	2	55	120	25.65	37.52	-0.63	1.66	-0.03	-0.34	1.4	-0.06
Coffeemaker	1	57	120	1413.04	13.32	0.98	0.03	-0.01	0.84	-0.3	0.46
Copier	1	48	120	944.23	84.57	0.52	0.45	0.03	0.39	-0.25	0.86
Electronic ballast	3	95	120	59.02	5.06	-0.07	0.08	0.99	9.32	-20.96	12.64
Elevator	3	110	208	1381.17	1008.3	2.36	-4.15	2.79	11.69	-19.5	8.81
Fan	2	20	120	163.25	83.28	0.26	0.9	-0.16	0.5	0.62	-0.12
Game consol	3	66	120	60.65	67.61	0.36	-0.58	1.22	0.34	-0.12	0.78
Halogen	3	20	120	97.36	0.84	0.51	0.55	-0.05	0.43	0.52	0.05
High pressure sodium HID	4	62	120	276.09	52.65	-0.16	1.2	-0.04	3.26	-4.11	1.85
Incandescent light	2	20	120	87.16	0.85	0.54	0.5	-0.04	0.46	0.51	0.03
Induction light	1	78	120	44.5	4.8	0.18	-0.75	1.57	7.51	-12.35	5.84
Laptop charger	1	46	120	35.94	71.64	0.25	-0.48	1.23	0.14	0.32	0.54
LCD Television	1	73	120	208.03	-20.58	0.33	-0.57	1.24	19	-33.22	15.22
LED light	1	81	120	3.38	5.85	0.69	0.92	-0.61	1.84	-0.91	0.07
Magnetic ballast	1	91	120	81.23	8.2	-3.16	6.85	-2.69	34.26	-64.04	30.78
Mercury vapor HID light	2	88	120	268.27	77.66	-0.16	2.33	-1.17	0.42	-1.01	1.59
Metal halide HID electronic ballast	2	80	120	113.7	26.37	-0.03	-0.06	1.09	11.4	-23.5	13.1
Metal halide HID magnetic ballast	2	47	120	450	102.94	-0.2	1.35	-0.15	1.37	-0.63	0.26
Microwave	2	85	120	1365.53	451.02	-0.27	1.16	0.11	15.64	-27.74	13.1
Minibar	1	58	120	90.65	126.94	3.95	-6.46	3.51	4.84	-6.64	2.8
PC (Monitor & CPU)	1	63	120	118.9	172.79	0.18	-0.26	1.08	-0.19	0.96	0.23
Projector	1	66	120	253	44	0.19	-0.45	1.26	10.18	-18.01	8.83
Refrigerator	1	60	120	119.55	52.47	5.03	-8.48	4.45	17.44	-28.62	12.18
Resistive heater	1	20	120	914.78	1.46	0.92	0.1	-0.02	0.15	0.86	-0.01
Tungsten light	1	27	120	256.2	21.04	0.45	0.66	-0.11	0.21	0.11	0.68
Vaccum	1	20	120	855	221	0.92	0.07	0.01	0.91	-0.02	0.11

Table III.2 ZIP parameters [89]

In the previous notation, the time-dependency of ZIP coefficients is omitted in order to have a clearer notation but they change during the time slots. In particular, later it will be considered a 10 minutes variation of the coefficients. In order to have the aggregate dwellings power/voltage dependency, the formula (III.5) - (III.11) are modified as follows: index i represents the selected dwelling and N_{Load} is replaced by $N_{dwelling}$ which represents the total number of residential units.

It is worth noting that non-residential loads will be considered as constant power loads and therefore as non responsive to voltage changes in order to evaluate the impact of residential loads.

III.4 Decentralized voltage-Led DR in low voltage distribution grids: the idea and implementation

In the previous chapter, voltage led demand response applied to the MV grids was introduced. Even if the service achieved successful results in terms of short terms power reserve, there are still margins for improving the technique. This chapter focuses on the use of the selected technique on LV distribution grids, in order to maximize the benefits of this approach.

Chapter III

As it is well known, the voltage along a feeder decreases due to the line losses.

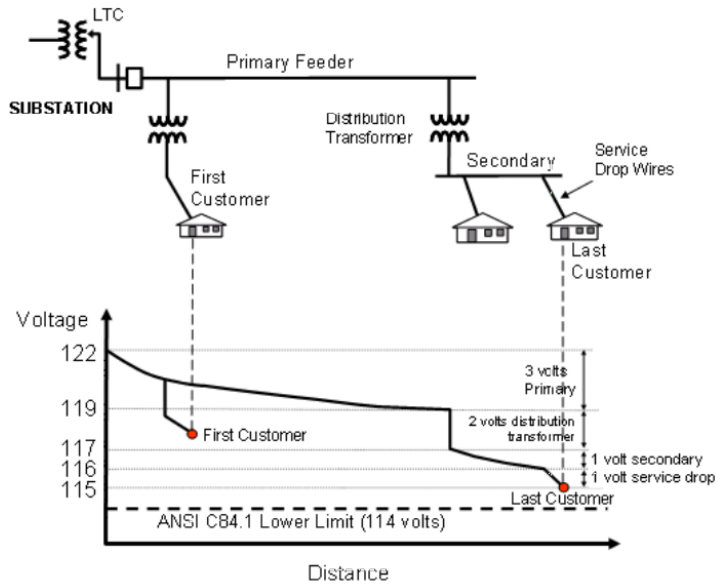

Figure III.9 Feeder voltage drop [93]

In Figure III.9, it is reported the voltage drop along a feeder from the primary substation equipped with OLTC to the last user on the selected LV grid. It is an American case study therefore the voltage values and limits are compatible with their standards. In Europe the reference standard is CEI EN 50160 which establishes that the supplied voltages must be inside the range $230 \text{ V}_{\text{rms}} \pm 10\%$ for 95% of the time [94].

As it is clear from the previous Figure, the last users set the maximum voltage regulating position tap of the primary substation OLTC in order to not violate the voltage values set by the standard. Indeed, line regulators and other devices can be used along the feeders to boost the voltages as presented for example in [74],[95] but they have to be coordinated besides positioned in the right position in the grid.

In this chapter, a new approach to regulate the active power consumption of residential units is introduced. The approach is called *fully decentralized*, since it is applied inside each final user dwelling, considered both as single or a cluster of units (apartments building). The advantage of the proposed solution is that it is possible to have a wider voltage regulation band and, therefore, a deeper effect in terms of active power reduction in the secondary distribution substation and as consequence on the primary substation. It does not act on the voltage levels on the feeders as capacitor banks or line drop compensators but it is a device that regulate single or multiple residential units power consumption inside them.

The research goes beyond the state of art, that is the application of voltage reduction technique at the primary distribution substation and it focuses on a *what if* analysis when the control is executed on the secondary transformer or on very local points in the LV distribution grids.

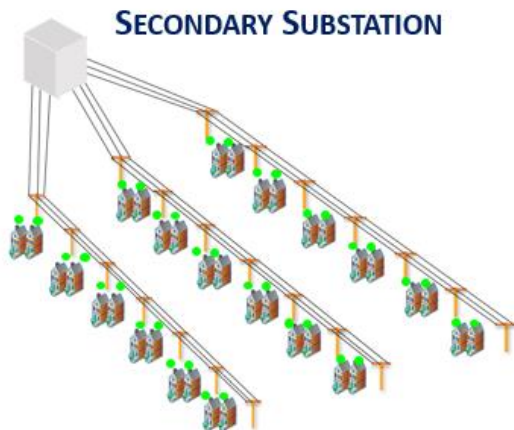

Figure III.10 *LV grid with decentralized control*

In Figure III.10 it is reported an example of LV-grid where the green dots represent the devices able to execute the voltage modulation at the dwelling points. The advantage of the solution is that the last customer is not the bottle-neck as seen before and the regulation margins are improved. The voltage regulation is executed in compliance with the standard CEI EN 50160. Furthermore, the solution provides a *power demand control service* since it is designed to be used when peak load, congestion and emergencies conditions occur.

In order to executed the control, it is introduced a novel device for DSO and DR service providers (DR-SP), called Regulating Smart Socket (RSS), able to apply DSM strategies in order to provide a fully decentralized voltage regulation aimed at the active power load control.

The RSS has been designed to be installed in residential units, that is houses, and it can be controlled by the DR-SP to modulate the power consumption in selected areas. It is possible to implement the RSS as single household regulating device, dwelling regulating device or apartments building regulating device. In this thesis, the first two options will be shown.

In literature, there are several smart sockets proposals which are used in Smart Home Energy Management Systems (SHEMS) to offer price sensitive load management service, peak load reduction and the optimization of the utilization of micro renewable generations and demand [96]-[101]. These designs are characterized by an *ON/OFF* function to apply DSM strategies but they do not allow an active power modulation, that is, instead, introduced by the proposed solution. Recently, a commercial solution has been

proposed [111], the V04, that provides the voltage reduction in the whole residential unit and it has the purpose of reducing the power absorbed (but not necessarily the energy!) and is not tied to any network service.

In Figure III.11, an example of the power demand control service based on the proposed enhanced SHEMS is provided; it is shown a section of LV distribution grid with a subset of loads, and each node models a cluster of residential units (RUs) managed by the DR-SPs and/or DNO as a power reserve when a power unbalance occurs (the power available it is not enough to cover the power demand).

The proposed approach provides a flexible and decentralized load control that is able to overcome both the limits set by the CVR and by the traditional Demand Response services. Specifically, referring to the latter, as well known, the effectiveness of DR services is significantly reduced by the uncertainty due to the voluntary and not mandatory contribution of the users to the service. Furthermore, in distribution grids DR services are not regulated as in Transmission grids and the results achievable are subjected to a high level of uncertainty.

Instead, the proposed solution ensures to the DR-SP the direct control of loads by the introduction of RSS. In this way, the DSO gains an additional degree of freedom in the load management since it controls the load profiles, providing power modulation in a decentralized way. An insight of the SHEMS architecture is shown in Figure III.12. The **SHEMS coordinator** is the device that communicates with both the RSSs and the DR-SP or DSO service provider (for instance by using a smart meter at the electrical interconnection point with the grid or a Power Line Communication – PLC - or an internet connection). Furthermore, it provides to the customers a Human Machine Interface (HMI) to set the configuration of each RSS, according to the users' preferences, and monitor the power demand.

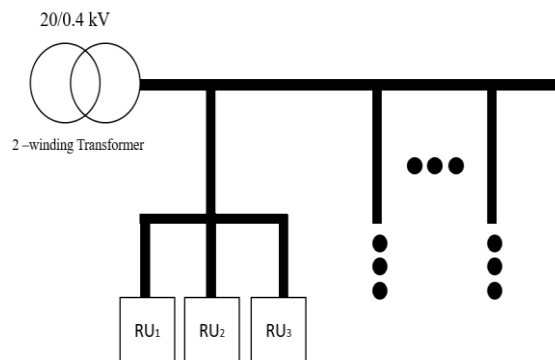

Figure III.11 Schematics of LV grid

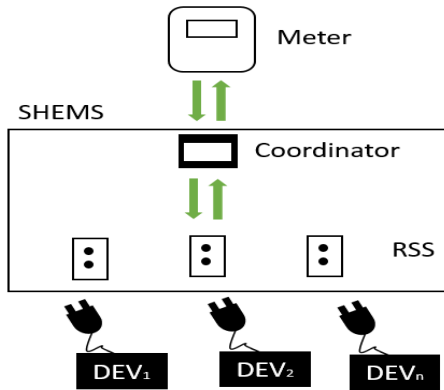

Figure III.12 SHEMS architecture

The power balance grid service using the SHEMS and RSS is implemented by the following operating cycle:

1. the DR-SP or DSO sends the request of power reduction to each SHEMS coordinator installed in the RUs of the controlled grid;
2. each SHEMS coordinator forwards the request to the RSSs or the central RSS in order to execute the command of voltage reduction (or switching off) to reduce the power load absorbed by each household device (DEV);
3. the control unit inside the RSS first evaluates if the measured voltage allows the voltage regulation then executes the received command.

In addition, the device has to be compliant with the standard IEC 61000-3-2:2014 which set the electromagnetic limits [102].

The structure of RSS is presented in Figure III.13 and it is composed by four main subsystems:

1. **sensor module**, used to monitor the plugged or cumulative household appliance consumption (current) and voltage;
2. **voltage modulator**, that allows the reduction of the voltage that supplies the household device or the dwelling;
3. **intelligent unit**, that controls the RSS; the control unit is an ultra-low power microcontroller whose main functions consist in:
 - receiving the commands sent by the SHEMS coordinator to reduce the voltage or switch off the plugged devices;
 - checking if the voltage allows the regulation;
 - driving the voltage modulator, in order to reduce the voltage supplied, assuring that the reduced voltage value is inside the right range;

4. **communication module**, that permits to the RSS to receive and send back commands and data from/to the SHEMS network coordinator. It is based on the 2.4 GHz IEEE 802.15.4 wireless protocol, a very low power.

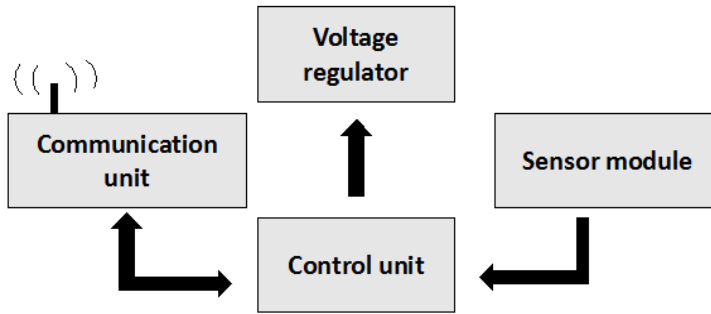

Figure III.13 RSS block diagram

III.5 Design of the AC/AC converter prototype

III.5.1 Single household regulator device

In this section an example of basic implementation of a single household regulator device is presented.

This version is a TRIAC based AC/AC converter configuration as shown in Figure III.14.

Following it is provided a summary description of the black boxes.

III.5.1.a Sensor module:

The sensor section is made up of two modules to execute current and voltage sensing: a Hall effect current sensor ACS750SCA-050 [103] and a voltage divider, respectively. The voltage divider is sized in order to have the voltage values inside the input range of the true RMS-to-DC converter AD8436 [104]. This module returns the DC value equal to the RMS value of the input AC waveform. As power supply for the sensing and the intelligent unit, we use the RAC 02-05SC RECOM, that has as input $230 V_{\text{rms}}$ and outputs 5 V and 400 mA [105].

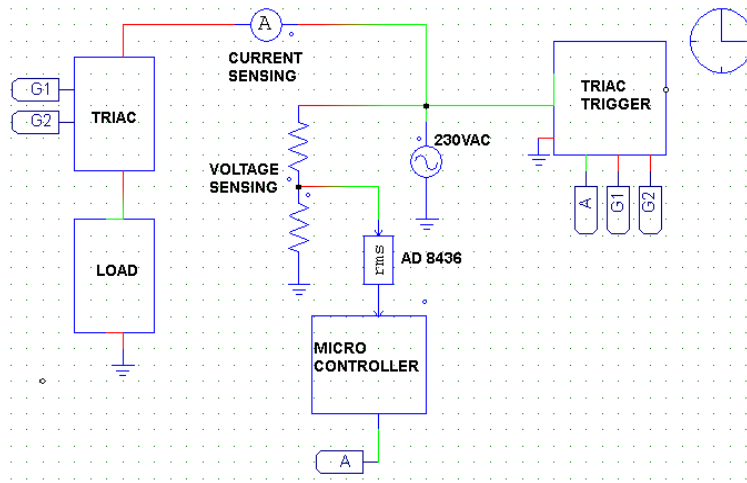

Figure III.14 Triac based converter

III.5.1.b Voltage modulator

As voltage modulator, the TRIAC-ST3035H [106] in TO-220AB package is used and it is driven by the microcontroller described in the next subsection. In order to separate the power side from the signal one, the driver random phase opto-coupler MOC3020 [107] is used.

III.5.1.c Intelligent unit: Microcontroller

The intelligent unit is the Texas Instruments ultra-low power 16 bit MSP430 microcontroller [108]. After the reception of the signal from the SHEMS and the evaluation of the measured voltage, in order to reduce the voltage value, the microcontroller has to undertake some actions. In the TRIAC based solution, the microcontroller must evaluate the delay ϑ [ms] to fire the TRIAC to ensure that the RMS voltage across the load is equal to the minimum value.

The value of θ is evaluated using (2):

$$V_{o_{rms}} = V_{i_{rms}} \sqrt{\frac{1}{\pi} \left(\pi - \alpha + \frac{\sin(2\alpha)}{2} \right)} \quad (\text{III.12})$$

where $\alpha = 2\pi f_s \theta$. In our case, we need $\theta = 3.2$ ms that guarantee $V_{o_{rms}} = 208$ V_{rms}. In addition, the microcontroller can also decide to disconnect the plugged load, ensuring a standard *ON/OFF* function. Finally, the control unit monitors the device's consumption using the current and voltage measured.

III.5.1.d Simulation and test results

The circuit presented has been implemented and tested using as device under test (DUT) a 60 W lamp. The RSS shown in Figure III.14 has been simulated by using PSIM: the microcontroller has as input the mains supply RMS value ($V_{i_{rms}}$) and as output, the delay θ to trigger the TRIAC. The TRIAC trigger module fires the TRIAC using the evaluated delay from the line voltage zero crossing in order to have the desired RMS voltage value across the load ($V_{o_{rms}}$).

In this analysis, the $V_{o_{rms}}$ is decreased to the minimum value allowed by the CEI EN 50160 standard, but changing the delay θ we can obtain a different $V_{o_{rms}}$ value. In Table III.3, the Fourier transform of the current is reported in order to check the limits set by the IEC61000-3-2 [102] for a class A device. As show, for a current value under 8 Arms the limits comply with the standard. These harmonics can be reduced by using a designed EMI input filter.

The power reduction is 10.9 W, when the L-N voltage value is 208 V_{rms}. The issue with this configuration is that RSS power dissipation is evaluated considering the TRIAC dissipation power since it is the most impacting element.

Harmonic number	Harmonic current limits (A)	Harmonic simulation value for 8 Arms (A)	Harmonic tested value for the DUT (mA)
3	2.30	1.81	60
5	1.14	1.08	30
7	0.77	0.54	20
9	0.4	0.4	10

Table III.3 Current Harmonics

The implementation of the RSS is presented in Figure III.15

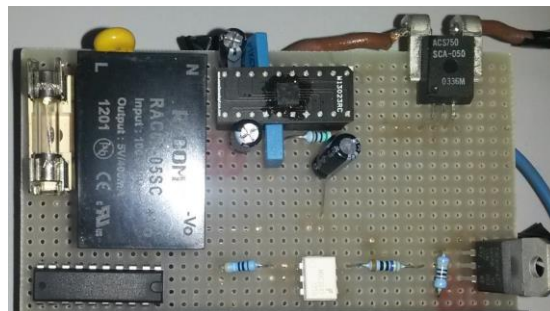

Figure III.15 TRIAC based solution prototype

III.5.2 Dwelling voltage regulator

In this paragraph, the voltage reduction is executed in the dwelling therefore it applies a voltage reduction in the whole RU. The solution is proposed in order to have better performance in terms of voltage quality, compared to the solution based on TRIAC.

The proposed architecture is the AC/AC converter shown in Figure III.16 based on a buck converter architecture.

In order to have a bidirectional current flow, switch cells are used. In particular, the cells are composed by IGBTs and diodes connected in a common collector back to back configuration [109] as in Figure III.17. The IGBT driver circuit is reported in Figure III.18 and it must be included for each switch.

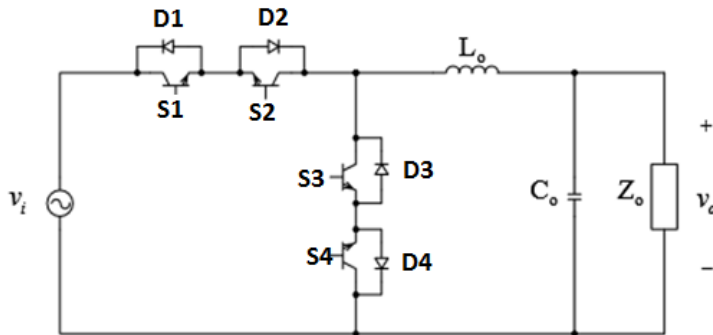

Figure III.16 Simplified AC/AC converter schematics [110]

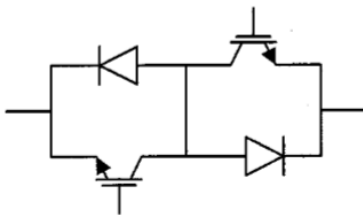

Figure III.17 Switches back to back configuration [110]

Chapter III

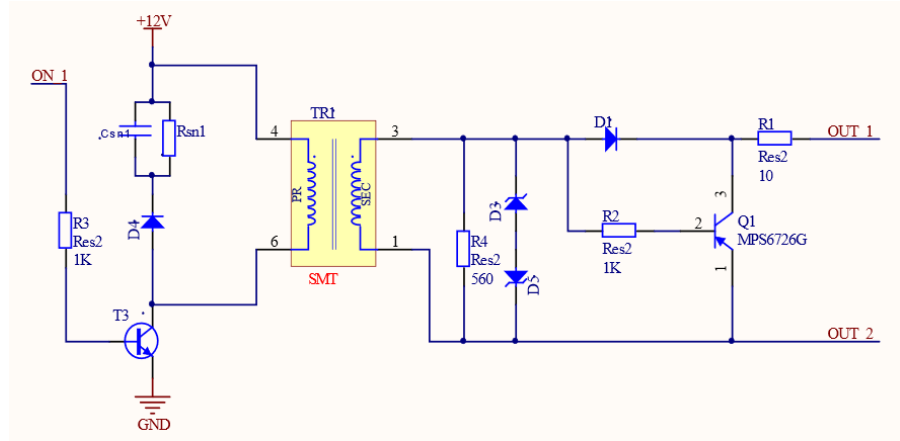

Figure III.18 IGBT driver circuit [110]

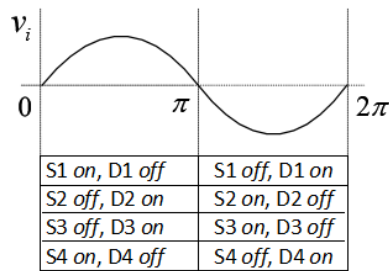

Figure III.19 Switching activation [110]

The *ON-OFF* switches activation is reported in Figure III.19: during the positive interval of the input voltage, S1, S4, D2, D3 are *ON* instead during the negative interval S2, S3, D2, D4 are *ON*. In this way, the AC current can flow in the converter.

Indeed, it must be respected a dead time between the activation of the switches in order to avoid that branches are short-circuited.

The converter control is executed using a hysteric control where the voltage reference is sinusoidal (Figure III.20). The details about the control and the design of the converter is reported in [110].

The simulation of the converter is presented in Figure III.21 where the input voltage is equal to 230 V_{rms} and the output voltage is equal to 208 V_{rms} with a ripple equal to 2.5 V.

Finally, the total harmonic distortion (THD) of an AC waveform is defined as:

$$THD = \frac{V_h}{V_1} = \frac{\sqrt{V_{rms}^2 - V_1^2}}{V_1}$$

where V_1 is the fundamental component, V_h is the harmonic rms value and V_{rms} is the overall rms value of the waveform.

For the designed circuit, the THD is equal to $5.015 * 10^{-3}$.

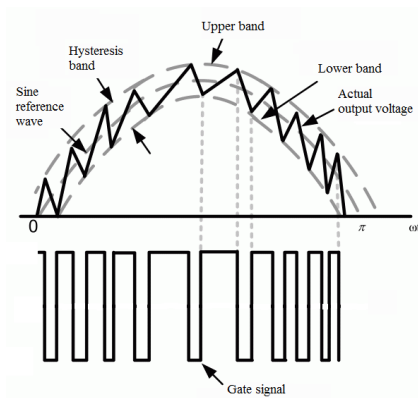

Figure III.20 Hysteretic control [110]

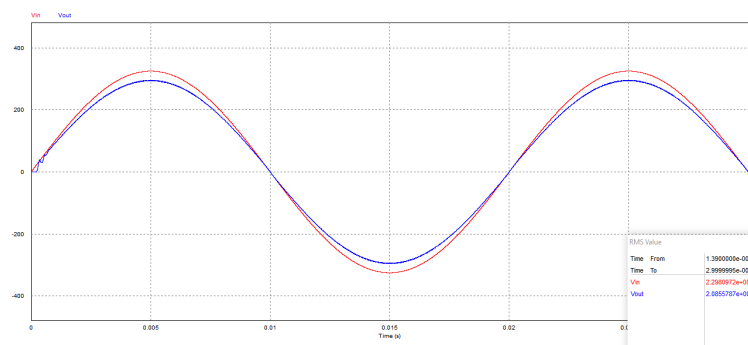

Figure III.21 Simulation output voltage [110]

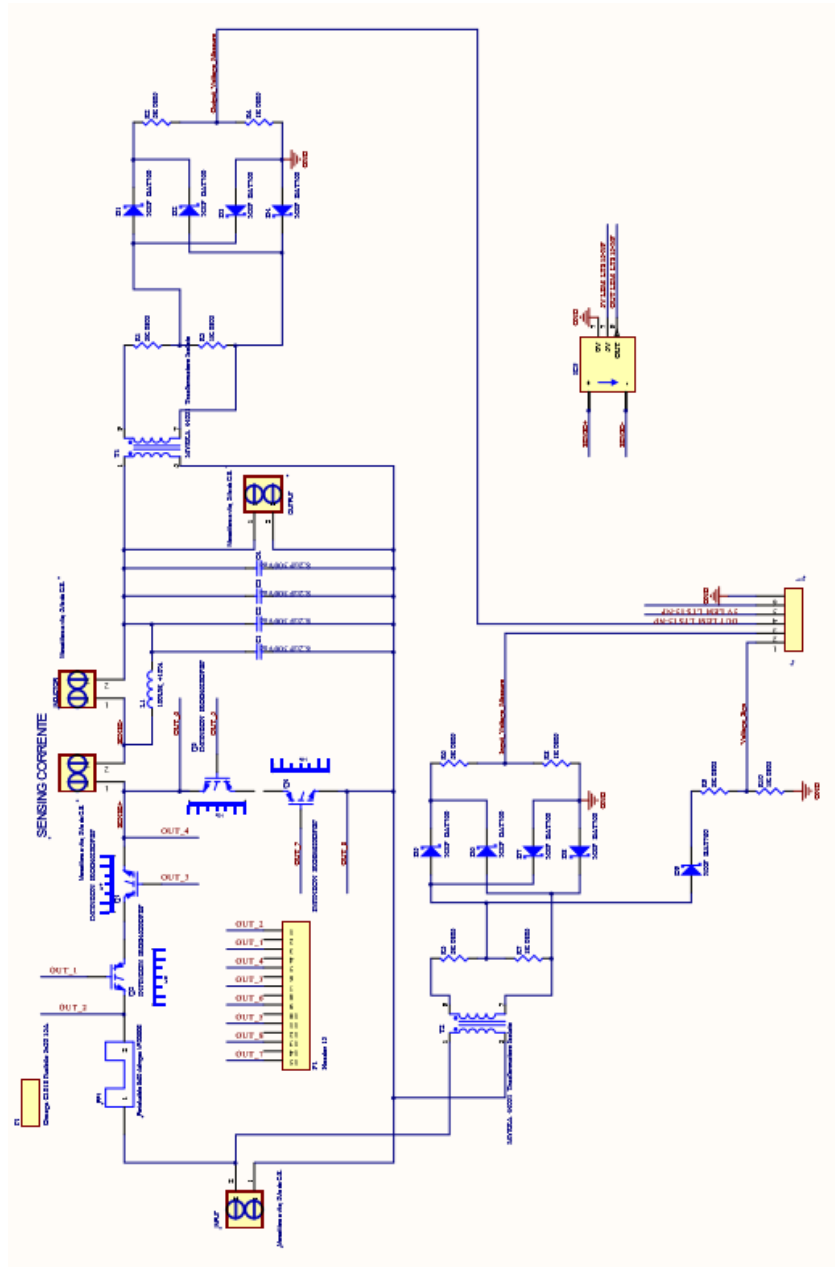

Figure III.22 Schematics of ACAC converter [110]

The ACAC converter schematic is presented in Figure III.22.

The prototype of the circuit is reported in Figure III.23 and Figure III.24, in particular, in the former it is presented the power circuit and in the latter the IGBT driver circuit.



Figure III.23 ACAC converter prototype [110]

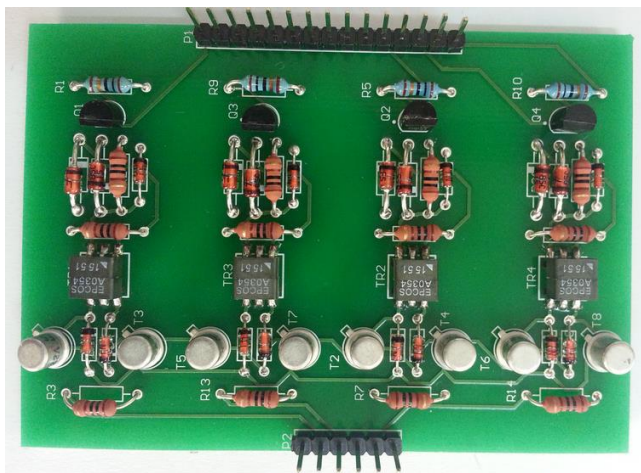

Figure III.24 IGBT driver prototype [110]

Chapter IV

Evaluation of the benefits of the fully decentralized voltage control in low voltage distribution grids

IV.1 Comparison between centralized and decentralized approach

As previously introduced, the proposed technique provides a fully decentralized voltage regulation action based on the relationship between the reactive and active power absorbed by electrical loads and the supplied voltages. This approach is different from CVR technique (previously introduced) since customers gain an independent and not centralized voltage modulation over the feeders. The proposed solution provides an additional degree of freedom for DSOs to guarantee the balance between the demand and the power available on the grid. In this paragraph, the effect of the voltage regulation is evaluated at the residential level; in particular, in LV distribution grids in which the concentration of RUs is predominant, e.g. smart cities.

The presented study focused on the comparison between CVR technique applied to OLTC fitted secondary distribution transformers (centralized control) and the decentralized voltage control based on the utilization of the novel service. RUs' loads are modelled using the time varying ZIP model presented in the previous chapters.

The decentralized active power control is provided by one of the two devices previously presented. Specifically, the smart regulating device is installed in a cluster of a few RUs (for example apartments buildings) and controlled by the DSO to manage the active power demand inside the

selected group of RUs through the direct control of the dwelling voltages according to the formula (III.1)-(III.4).

IV.1.1 Grid description

The simulations are executed on the grid presented in Figure IV.1. The grid was realized in the ATLANTIDE project [112] and it represents a typical Italian LV grid. The most diffused structure is radial therefore the selected grids will be radial. According to a study in [113] the most diffused LV grids are characterized by the following transformer size: 100 kVA (for low density population), 250 kVA (for medium density population) and 400 kVA (for high density population).

In this chapter, two versions will be presented, the second version will be shown later. The first grid is a *clustered grid*, i.e. each node in the grid is a cluster of residential loads. The grid is long 2 km and it include all single-phase loads. The lines are characterized by 3 phases + neutral cables with non-uniform sections, according to the load density as reported in Table IV.1 and Table IV.2. In our case studies the grid is slightly modified from the original one that can be found in [112].

The network is unbalanced and it consists of 4 feeders (feeder 1 to feeder 4) each composed by 7 nodes. Each node is a cluster of 4 RUs, therefore the maximum rated active power absorbed by each node is equal to 13.2 kW, according to the typical residential energy contract (3.3 kW) applied by the Italian DSO [114]. In addition, we assume that the load power factor is equal to 0.98 and only single-phase loads are in the grid. The LV grid is connected to the medium voltage (MV) grid through a 10/0.4 kV, 2 windings Δ/Y transformer with $V_{CC} = 4\%$ and rated power equal to $S_T = 400$ kVA. We assume that the grid is passive, that means there is not generation from RESs

V.1.2 Load configuration

Each RU is made up of an aggregation of household devices, which are switched *ON* and *OFF* in different periods (each of which defines a time slot) during the day. Each RU is characterized by an independent daily demand and the utilization of a selected device is strictly bound to the probability of its use during each time slot of the day. Load configuration during $\Delta t = 10$ minutes does not change but the RU loads change between consecutive Δt even though it is ensured the temporal sequence of the cycling loads, such as washing machines and dishwashers.

Chapter IV

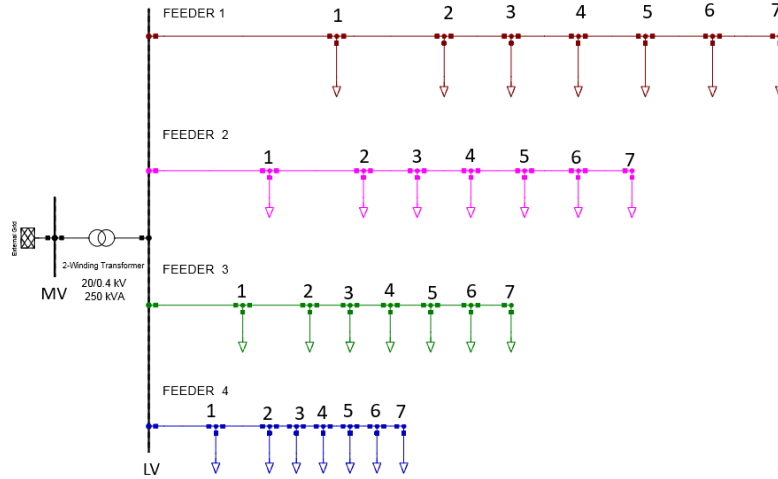

Figure IV.1 LV distribution grid [112]

Cables	r (Ω/km)	X (Ω/km)	r _n (Ω/km)	X _n (Ω/km)
3x95 mm ²	0.25	0.07	0.5	0.07
3x 50 mm ²	0.39	0.07	0.8	0.07
3x 35 mm ²	0.87	0.078	1.5	0.078
3x 16 mm ²	1.2	0.08	1.2	0.08

Table IV.1 LV grids cables parameters [112]

Cables Feeder	Length 3x95 mm ²	Length 3x50 mm ²	Length 3x35 mm ²	Length 3x16 mm ²	Total Length
	Feeder 1	500	300	-	
Feeder 2	400	200	-	-	600
Feeder 3	-	300	100	-	400
Feeder 4	-	-	150	50	200
Total	900	800	250	50	

Table IV.2 LV grid feeders' length [112]

The RUs' daily load patterns are evaluated using the tool developed by the University of Loughborough [115], adapted for the Italian typical loads and previously described. By using the tool, it is possible to have the active and reactive power of each household device in Δt .

In particular, in each Δt , it is defined a vector L_N such that:

$$\forall \Delta t_k, \exists L_N^k = \{l_{j=1}^k, l_{j=2}^k, \dots, l_{j=N}^k\}, \quad k = [1, \dots, 144], \quad l_j^k = \begin{cases} 0 \\ 1 \end{cases} \quad (\text{IV.1})$$

where k is the k -th 10 minutes interval during the day and it ranges between 1 and 144, l_j defines if the household device j is *ON* or *OFF* during the selected time slot. Once defined L_N , it is multiplied by the active/reactive power consumption of each household device in order to have the cumulative RU power.

Finally, the RU is modelled using a cumulative ZIP model in order to analyze the variation of the dwellings power absorption when the supplied voltage changes inside the limits set by the standard CEI EN 50160 as previously shown.

IV.1.3 Simulation routines and results.

In order to evaluate the results, a Monte Carlo simulation approach is used with simulation period equal to 24 hours and simulation step (time slot) equal to $\Delta t = 10$ minutes. To define different load configurations, the formula (IV.1) is completed as follow:

$$\forall m, \exists \{L_N\}_m, m = [1, \dots, 500] \quad (\text{IV.2})$$

where m is the Monte Carlo iteration and $\{L_N\}_m$ says that there is a different L_N for each iteration.

The algorithm implemented is organized in two subroutines, one for the CVR simulation (**Routine A**) and the other for the decentralized control (**Routine B**). They are included in the **main routine** that is executed during each Δt . The main routine (Figure IV.2) is run for 144 times since the total simulation period is equal to 24 hours, that is 144 time slots. At the beginning of each time interval Δt , the loads configuration of each RU and consequentially of each cluster of loads is set and the secondary voltage of the MV/LV transformer is set to 400 V.

After this preliminary configuration, both routines are called in order to obtain the simulation results.

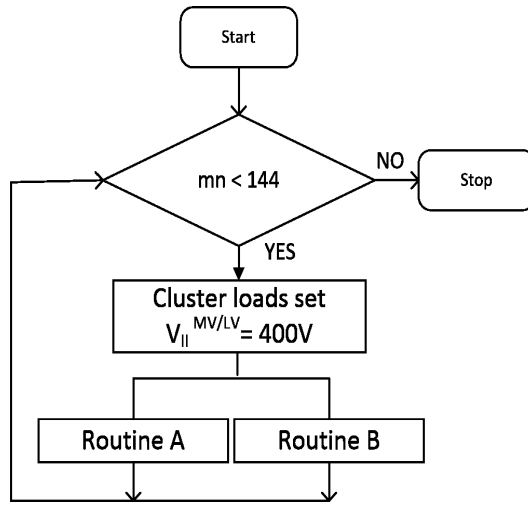

Figure IV.2 Main Routine

Routine A (Figure IV.3) is the routine that simulates the CVR regulation.

The first step consists in reducing the MV/LV secondary voltage, $V_{II}^{MV/LV}$, by $\alpha = 1\%$ of the nominal value. The minimum value is $V_{II(min)}^{MV/LV} = 360$ V.

The unbalanced power flow is run and voltages value over the feeders are checked: if all the values are inside the limits set by the standard, it is possible to repeat the routine, otherwise the routine stops and saves the results (power flow results) calculated in the previous step where the voltages violations do not occur.

Routine B is presented in Figure IV.4 and it executes the decentralized voltage control. In this routine, voltages inside the RUs are modified without changing the MV/LV secondary voltage. The routine starts running the unbalanced power flow in order to check all the voltages over the feeder and on the load clusters. After, the routine reduces the local load voltages by a variable amount so that each RU's supplying voltage is equal to 0.90 p.u, using a scaling factor called v . The voltage reduction leads the cluster loads to assume different values according to (III.1- III.4) and therefore to have a power modulation on the distribution transformer. Finally, a last unbalance power flow is run in order to assure that no voltage violations occur.

The two subroutines are executed using the same load configuration in order to compare the impacts on the grid of the two strategies. In this paper, we analyze two case studies: the former based on the random allocation of power demand on each cluster of loads, the latter consists in using cluster of loads composed by 3 RUs with an active power demand for most of the time equal to 3.3 kW. The former is a typical power demand condition, whereas the second is a peak demand condition implemented in order to underline the effectiveness of the proposed solution.

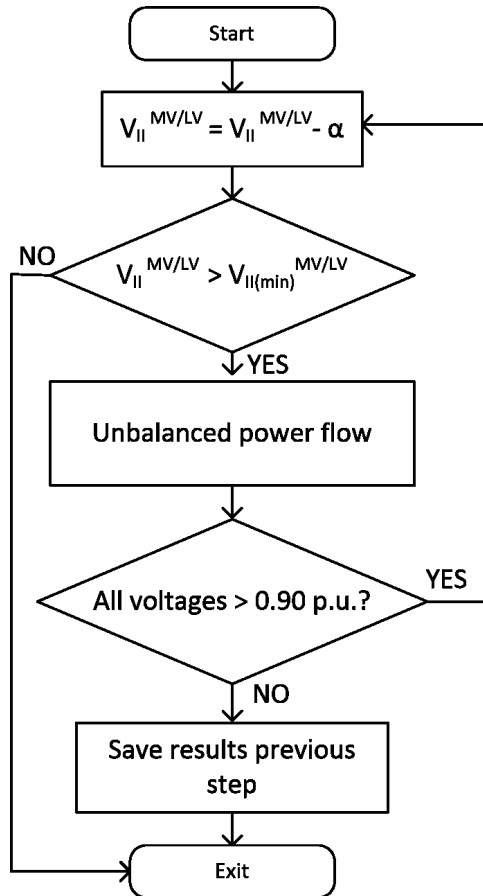

Figure IV.3 Routine A

Simulations are performed by using OpenDSS [116] and MATLAB. We use the standard CEI EN 50160 as reference to recognize voltage violations, which set the 10 minutes-mean of the supply voltage equal to $1.00 \text{ p.u.} \pm 10\%$. In the model, the decentralized control decreases the DEVs' supplying voltages to the minimum limit, that is 0.90 p.u. , and the CVR control reduces the secondary voltage of the MV/LV transformer by steps equal to 1% of the rated voltage, as described in Section III. In Figure IV.5, the active power measures at the MV/LV transformer for each phase is reported and it is analyzed for the first case study, described in III. In particular, with the black, red and green lines we report the not regulated, the CVR controlled and the decentralized controlled active power curves, respectively.

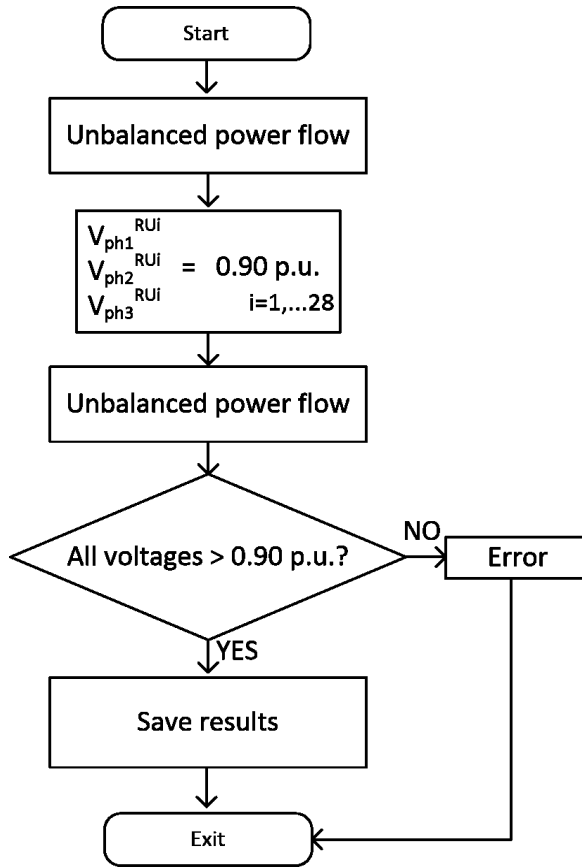

Figure IV.4 Routine B

Indeed, the effectiveness of the decentralized control compared with that obtained using CVR, is most relevant during the peak hours, instead during the off-peak periods it has the same impact in terms of peak power reduction. Therefore, the most relevant effect of the decentralized control is evaluated during the peak load condition (second case study) as shown in Figure IV.6. In the figure, the active power using the decentralized voltage control is lower than both the case without regulation and the CVR, providing a relief effect to the grid. In addition, by using the square and line patterns, we pinpoint on the regulating ranges for CVR and the decentralized technique, respectively.

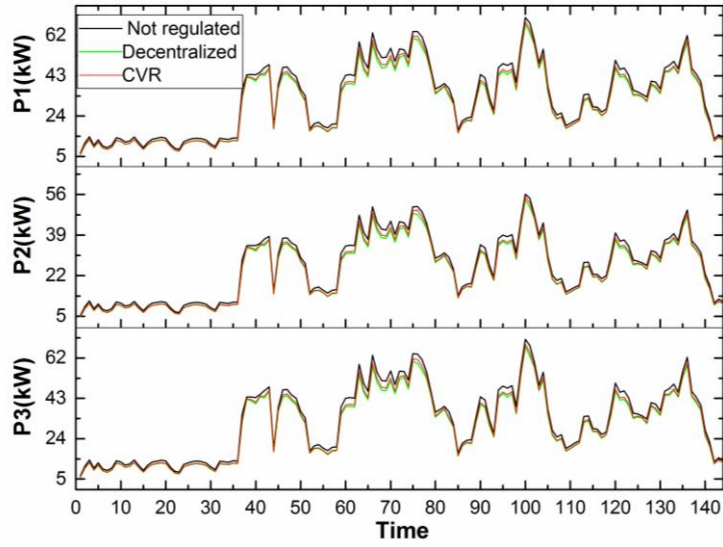

Figure IV.5: Daily active power profiles at the MV/LV transformer

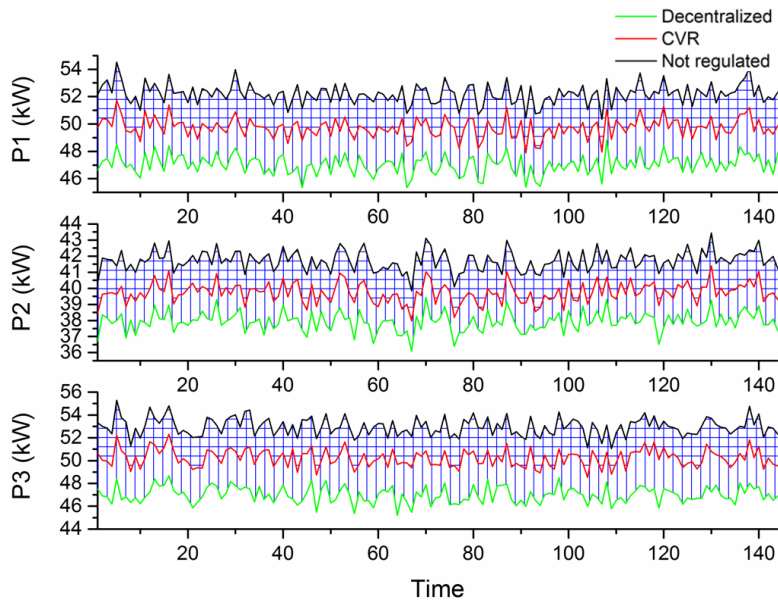

Figure IV.6 Active power regulation range

Control technique	Average active power reduction (%)	Voltage measured (p.u.)
CVR	5	0.94*
Decentralized	7	0.90**

Table IV.3 Comparison of control techniques (case A)

Control technique	Average active power reduction (%)	Voltage measured (p.u.)
CVR	4	0.96*
Decentralized	9	0.90**

Table IV.4 Comparison of control techniques (case B)

It is possible to note that in this case the decentralized control offers a wider regulating range and therefore more flexibility in using it as a power reserve service during peak period. In Table IV.3 and Table IV.4, the average active power reduction and the average working voltage measured for CVR and the decentralized control in the two case studies are reported. In detail, the average active power reduction is evaluated as percentage referred to the case without regulation (black line in Figure IV.5 and Figure IV.6). The working voltage is expressed in p.u. and for CVR it is measured at the secondary terminal of the distribution transformer, whereas for the decentralized control it is the voltage measured point by point, that is to say inside the RUs. Using the decentralized control, the voltage is set equal to 0.90 by the modulation introduced by the RSS.

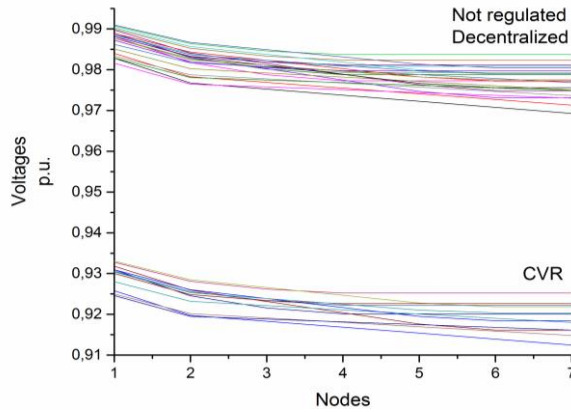

Figure IV.7 Feeders voltages

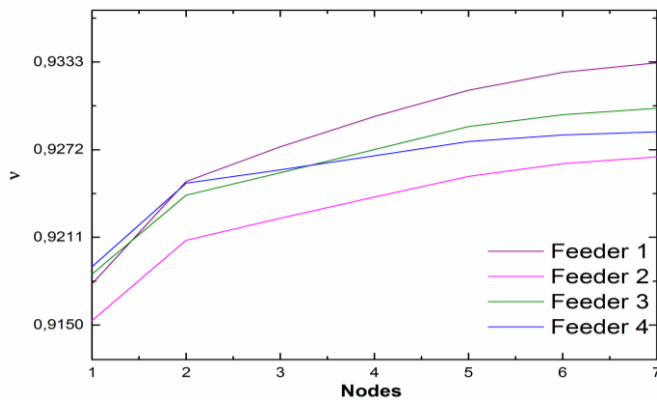

Figure IV. 8 RSS regulation

In detail, the RSS executes the voltage sensing and consequently, evaluates the reduction factor v in order to lead the DEV's supplying voltage to be equal to 0.90 p.u.. In Figure IV.8, the average RSSs reduction factor v , over the 4 feeders is shown. The coefficient increases over the feeders since it depends by the measured voltages, therefore, it is lower at the beginning of the feeder and higher at the end of it. The daily average of the voltages over the feeders are analyzed in Figure IV.7. It is possible to note that since the decentralized control reduces the voltages inside the RUs, not regulated and decentralized control voltages are almost overlapped. By using CVR control, voltages on the feeders decrease, leading the values to be close to the lower limit set by the standard. The results are evaluated for a small LV distribution grid, therefore the gain in terms of active power reduction is tight but including several residential areas, the impact can be significant when peak load or contingences events occur.

IV.2 Fully Decentralized Load Modulation Approach to Improve DSO Flexibility in Low Voltage grids

In this paragraph a new case study is performed on LV distribution grid. In this analysis, it will be tested the fully decentralized power control (FD-PC) on a LV active grid (i.e. there are some PV power plants) and it will be shown how the proposed technique helps the management of the grid and provides a good source of flexibility to the DSO.

IV.2.1 Grid description

The LV grid is described in [112], here slightly modified by the introduction of 3 three-phase PV power plants (2 with active power equal to 10 kWp, 1 with active power equal to 15 kWp) and power factor equal to 1, and 30 single-phase PV panels characterized by active peak power equal to 3 kWp and power factor equal to 1 and presented in Figure IV.9. The grid is composed by 136 single-phase loads with maximum active power equal to 3 kW and 9 three phases loads with a cumulative peak active power equal to 45.9 kW.

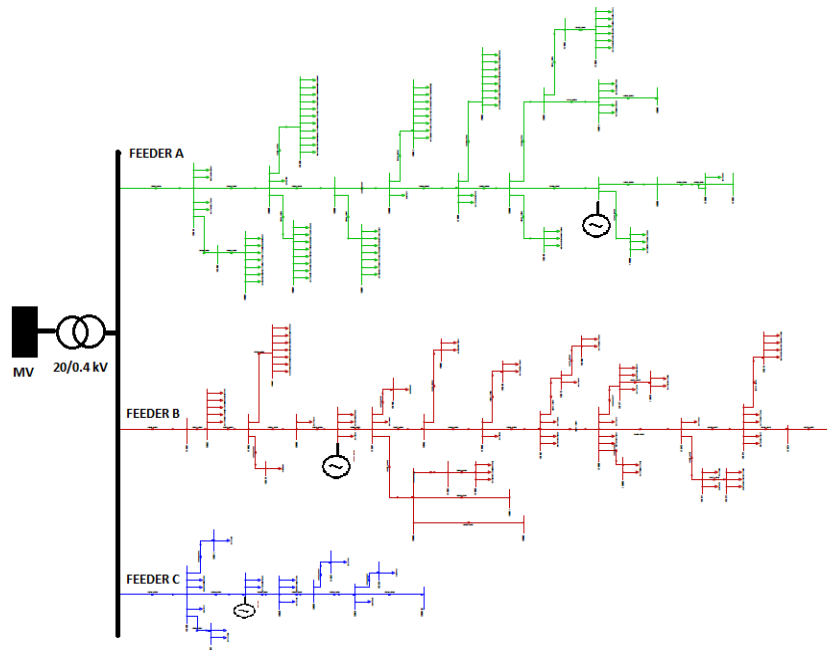

Figure IV.9 LV grid with PV panels [112]

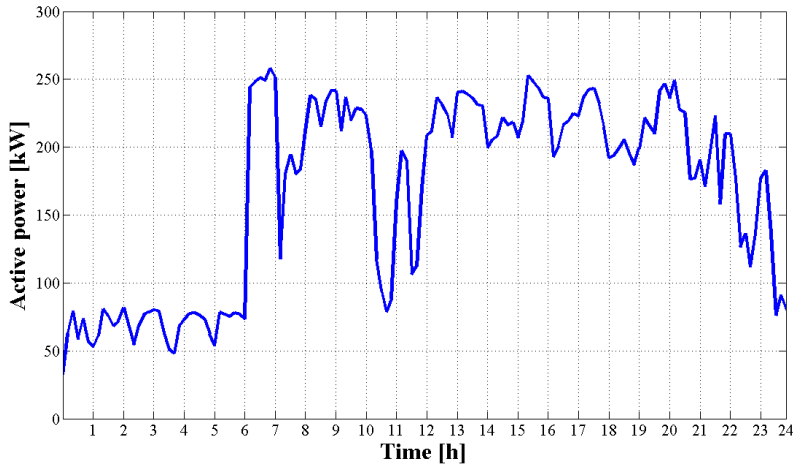

Figure IV.10 Residential active power profile

The LV grid is connected to the medium voltage (MV) grid through a 10/0.4 kV, 2 windings Δ/Y transformer with $V_{CC} = 4\%$ and rated power equal to $S_T = 400$ kVA. Furthermore, the network is unbalanced and it consists of three feeders, called A, B and C.

The typology of cables (3 phases + neutral) and their technical information are reported in Table IV.5.

Cables	r (Ω/km)	X (Ω/km)	r_n (Ω/km)	X_n (Ω/km)
CI-3x95+50C	0,19	0,07	0,39	0,07
CI-3x6+6C	3,1	0,09	3,1	0,09
CI-3x50+25C	0,39	0,07	0,73	0,09
CI-3x25+25C	0,73	0,09	0,73	0,09
CI-3x16+16C	1,2	0,08	1,2	0,08
CI-2x6	3,1	0,095	3,1	0,095
CA-4x6	3,1	0,1	3,1	0,1
CA-4x10	1,9	0,1	1,9	0,1
CA-3x50+25	0,39	0,078	0,73	0,079
CA-3x35+54A	0,87	0,078	0,63	0,15
CA-2x6	3,1	0,096	3,1	0,096
CA-2x10	1,9	0,1	1,9	0,1

TableIV.5 LV grid parameters [112]

The RUs' daily load patterns are evaluated using the approach shown before and the average active power in the grid is shown in Figure IV.10.

The single-phase PV panels are randomly located and connected to the selected RU. The *three-phases* PV plants are located in fixed position, as shown in Figure IV.9.

IV.2.2 Case studies

Simulations are executed using the Monte Carlo simulation approach, with the total simulation period equal to 24 hours divided in $\Delta t = 10$ min time slots (simulation step), therefore the simulation is spread over 144 time slots.

The analysis is performed in two operating conditions depending on the tap position of the secondary distribution transformer, that is 1 p.u. (**case A**) and 1.05 p.u. (**case B**) of the nominal voltage. We assume that 1.05 p.u. is the estimated maximum limit in order to not violate the CEI EN 50160 standard in the presence of PV panels in the grid. The FD-PC adaptively decreases the RUs supplying voltages to the minimum limit set by the standard, using the following formula:

$$\eta = V_{sense} - V_{-10\%}$$

where η is the RSS reduction factor, V_{sense} is the measured voltage at the customer dwelling and $V_{-10\%}$ is the lower limit.

The simulations are carried out in order to evaluate the impact on the proposed LV grid for the two case studies. In addition, the simulations are performed on the whole day in order to pinpoint the most effective time slots.

Voltages over the feeders are reported in Figure IV.11 for case A and Figure IV.12 for case B, when FD-PC is not executed.

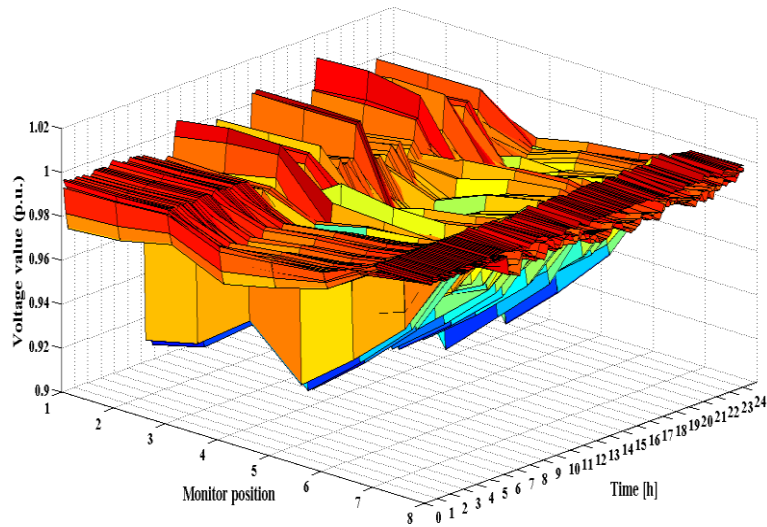

Figure IV.11 Case A: voltages over the feeders

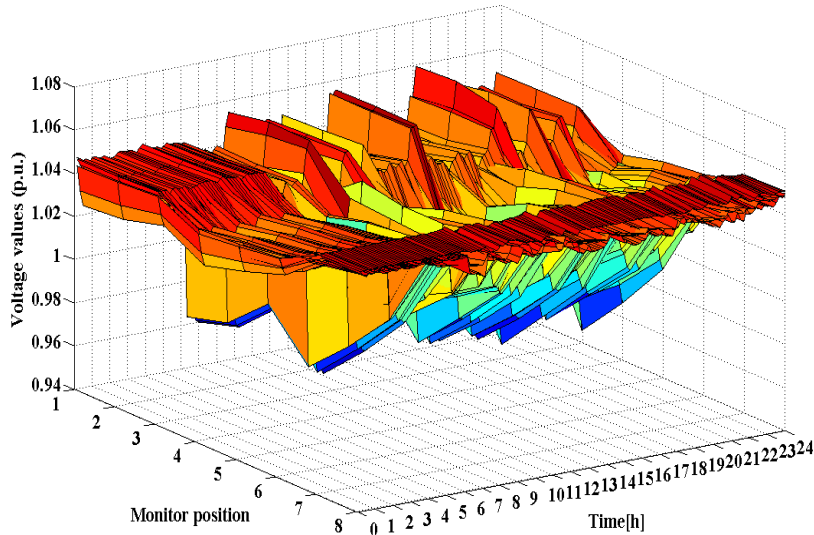

Figure IV.12 Case B: voltages over the feeders

As it is shown, in the case A, some RU voltages are close to 0.90 p.u., therefore it is assumed that the DSO sets the distribution transformer tap to 1.05 p.u. to ensure a better quality of service and grid reliability. In both cases, the supply voltage provided to the RUs is voluntarily reduced to the minimum limit to provide the short-term power reserve, therefore the households active and reactive power consumption changes compared to the one associated to the rated supply. Following, this case is called “**regulated case**” and the not regulated case is called “**base case**”.

In the following figures, the blue, red and green bars represent the values obtained for the three phases. In Figure IV.13 it is reported the hourly average active power reduction (as percentage) at the secondary distribution transformer compared with the base case. This reduction represents the short-term power reserve that the DSO gains by applying the FD-PC.

It is worth to note that each FD-PC device is independent by the other devices, and consequently, it is possible to have a *phase by phase* power modulation. In addition, the best results are achieved during the peak hours. Even during the night there is a percentage of modulation since we assume that in a set of RU dishwashers and washing machines are working. The secondary distribution transformer average losses compared to the base case are -5%.

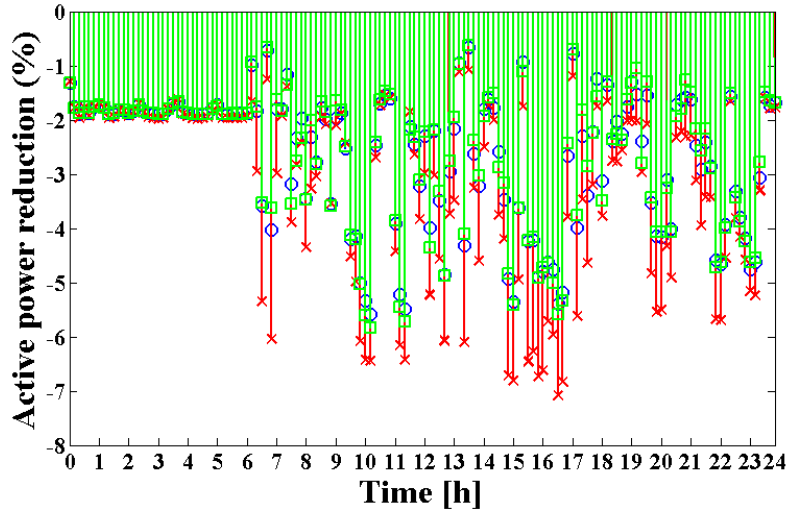

Figure IV.13 Case A: percentage active power reduction

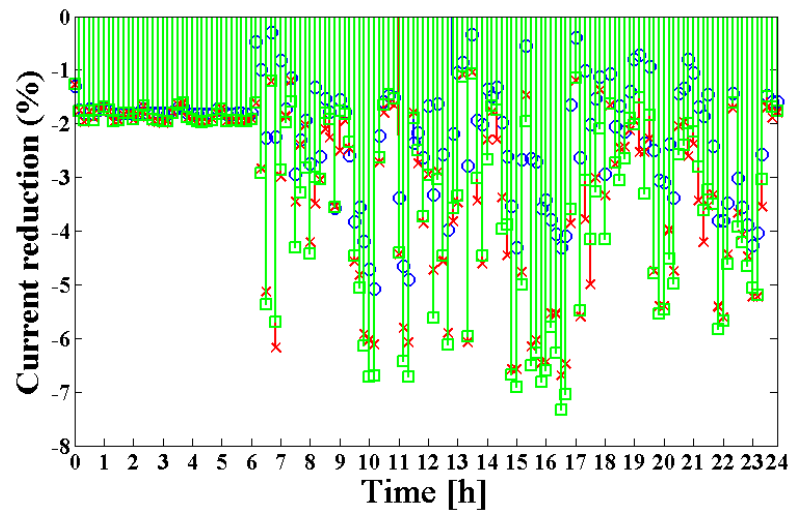

Figure IV.14 Case A: percentage current reduction

The currents over the feeders are reported in Figure IV.14 and also in this case, there is a current reduction compared to the base case (in percentage). This allows a relief effect on the lines in terms of thermal effects and line congestion due to the exceeding of the cables current ratings. Since the selected LV grid is characterized by voltage values close to the lower limit, it is not possible to apply a secondary substation-based approach, unless the grid infrastructure is not enhanced with voltage boosters. The corresponding results obtained in the case B, are reported in Figure IV.15 and Figure IV.16 and the secondary distribution transformer losses are -10% compared with

the corresponding base case. If the DSO has a full control on the secondary substations using on load tap changer transformers, this operational condition has the best results in terms of power and voltage reduction and grid stability, since the voltages are far from the upper and lower band set by the standard. Once again, by applying the FD-PC the DSO gains an additional degree of freedom in the power management of the LV grids. Therefore, the strength of the fully decentralized approach is the adaptive supply voltage reduction over the feeders that allows to achieve significant power regulating margins on the secondary distribution transformer and local short term reserves in LV grids.

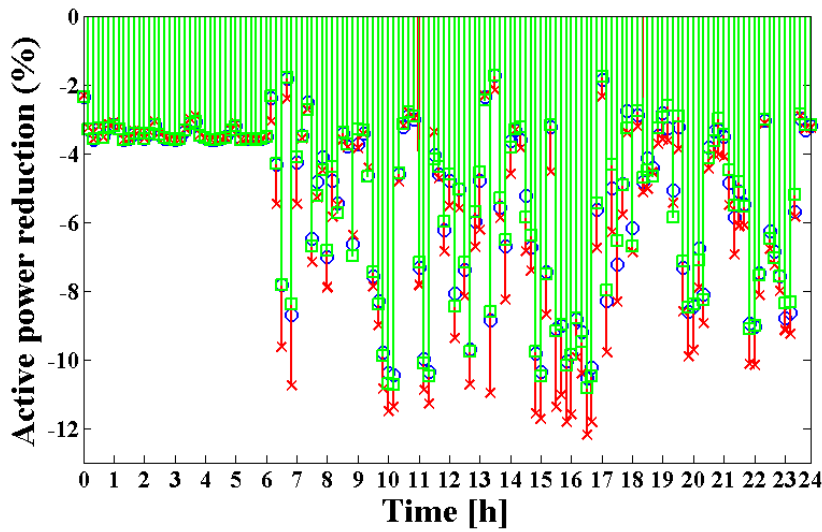

Figure IV.15 Case B: percentage active power reduction

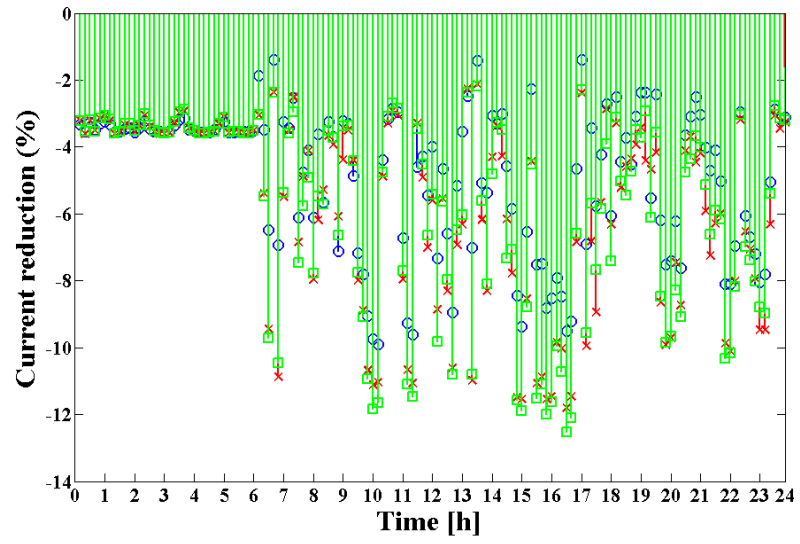

Figure IV.16 Case B: percentage current reduction

Chapter V

Conclusions

V.I Summary of dissertation

The growing concern about environmental issues has led to a major interest in the sustainable development of power system, both in terms of generation and demand resources. For the former, RESs have introduced significant changes in power production. The high penetration of RES have strongly impacted the grid, increasing uncertainty about the production in the generation mix. In fact, the volatility of RES power production have led DSOs to face significant uncertainty in the balance between supply and electrical demand around the clock, requiring an increase of energy reserves from traditional sources, thus losing both the economic and environmental benefits related to the use of renewable sources. Therefore, to manage this situation, the flexible control of the available energy resources and loads has become necessary. New and more extensive control actions to balance supply and demand for both energy and power are required. The deeper involvement of electrical demand in the grid control, such as DR programs and ESSs, has been the most meaningful consequences of this new scenario. DR has begun to support the attain of supply-demand balance around the clock both in energy markets (from capacity to real time markets) and in distribution grids in order to unlock demand capacity. If in the energy markets DR role is well establish and subjected to rules to be considered an active energy resources, in distribution grids DR contribute is still not totally available due to the dominant presence of residential customers.

In this PhD dissertation, the role of demand side flexibility has been analyzed from the transmission to the low voltage distribution grid in order to pinpoint the opportunity to use demand flexibility in power system.

Under this reference context the main contributes of this dissertation are:

- **Analysis of the impact of DR in the energy markets.** The analysis has been described in Chapter 2, focusing on the quantification of the variable effects of the integration of DRRs in power system with

Chapter IV

integrated RESs and utility-scale energy storage systems with the various sources of uncertainty explicitly represented. It has been deployed a stochastic simulation approach based on Monte Carlo techniques to emulate the U.S. transmission-constrained hourly day ahead markets over longer term periods. Salient characteristics of the approach have been the ability to represent the spatial and temporal correlation of the loads and the renewable resources, the ability to explicitly represent the payback characteristic of DRRs. The results have been carried out using a modified version of a real U.S. transmission bus-system to perform various case studies to evaluate the economics, emissions and reliability metrics. The studies have shown the strong capabilities of the approach and provide insights into the impacts of deepening penetration of DRRs under different intensity levels.

- **DR flexibility in low voltage grids.** The contribute has been described in Chapter 3 and Chapter 4. A decentralized active power control to manage residential power in low voltage grids has been proposed as opposed to the centralized control, as conservation voltage reduction technique. In particular, the power service have been aimed at improving DSOs flexibility when overload occur. It has been designed as a fully local control which modulates the voltage in the single or group of dwellings in order to exploit all the voltage regulation band defined by the standard CEI EN 50160. The straightness of the proposed control has been its modularity and its local feature since it executes an adaptive voltage regulation according to the measured voltages. In this way, downstream customers are not setting the maximum downward limit as in the centralized control. In Chapter 3, the service and its technological design to be included in a smart energy management system managed by DSO in residential units has been introduced. In Chapter 4, the solution has been simulated on a typical Italian low voltage grids made up of all residential customers. The case studies have shown the advantage in using the decentralized control compared to the centralized one in terms of active power reduction at the secondary distribution transformer and in line current reduction.

V.II Future direction of the research

The research topic is very complex and there are lots of aspects to take into account in order to have a comprehensive analysis.

About the integration of DR in the energy markets, a model about the CSPs can be integrated in the optimization routine in order to achieve more detailed results and an overview about the variability of demand participating in DR programs.

About the integration of voltage led DR, it is worth focusing on the economics aspect of the proposed solution to check the economics benefits

compared with the activation of generation reserves and the use of the CVR based approach.

Finally, another aspect to be investigated is the development of the technological solution, from the communication protocol to the converter design.

Reference

- [1] International Energy Agency (IEA), “World Energy Outlook 2015”, available on line at url <http://www.worldenergyoutlook.org/weo2015/>
- [2] P. Nejat, F. Jomehzadeh, M. M. Taheri, M. Gohari, M. Zaimi, A. Majid “A global review of energy consumption, CO₂ emissions and policy in the residential sector (with an overview of the top ten CO₂ emitting countries)” in *Renewable and Sustainable Energy Reviews*, vol. 43, pp. 843-862, 2015
- [3] International Energy Agency, “Energy efficiency requirements in building codes, energy efficiency policies for new buildings”, Information paper, 2008.
- [4] International Energy Agency, “Monthly Energy Review”, 2016. Available at url:<http://www.eia.gov/totalenergy/data/monthly/#consumption>
- [5] IEA-ETSAP, IRENA©, "Renewable Energy Integration in Power Grids, Technology Brief", April 2015. Available at url: http://www.irena.org/DocumentDownloads/Publications/IRENA-ETSAP_Tech_Brief_Power_Grid_Integration_2015.pdf
- [6] REN21, "Renewables 2016, Global status report", 2016. Available at url: http://www.ren21.net/wp-content/uploads/2016/06/GSR_2016_Full_Report.pdf
- [7] D. Lew et al., “Impact of high solar penetration in the western interconnection”, Technical Report, National Renewable Energy Laboratory, December 2010.
- [8] J. Bank et al., “High penetration photovoltaic case study report,” Technical Report, National Renewable Energy Laboratory, January 2013.
- [9] International Energy Agency (IEA), “Technology Roadmap - Smart Grids”, available on line at url https://www.iea.org/publications/freepublications/publication/smartgrids_roadmap.pdf

Chapter IV

- [10] T. Morgan, “Smart Grids and Electric Vehicles: Made for Each Other?”, in *International Transport Forum*, 2012.
- [11] H. Kanchev, D. Lu, F. Colas; V. Lazarov; B. Francois, “Energy Management and Operational Planning of a Microgrid with a PV-Based Active Generator for Smart Grid Applications” in *IEEE Transactions on Industrial Electronics*, vol 58, issue 10, pp: 4583 – 4592, 2011
- [12] European Commission energy research knowledge center, “Energy research challenges for Smart Cities”, 2014. Available at url: https://setis.ec.europa.eu/energy-research/sites/default/files/library/ERKC_PB_Smart_Cities.pdf
- [13] P.S. Nielsen., S. Ben Amer , Halsnæs, K., “Definition of Smart Energy City and State of the Art of 6 Transform Cities using Key Performance Indicators”, *EU-FP7 TRANSFORM project Work Package 1, Deliverable 1.2*, Available at url: http://orbit.dtu.dk/ws/files/60555188/Definiton_of_smart_city_D1.2_FINAL.pdf
- [14] F. Katiraei, R. Iravani, N. Hatziargyriou, and A. Dimeas, “Microgrids management”, in *IEEE Power and Energy Magazine*, vol. 6, pp. 54-65, 2008.
- [15] Y. He, G. J. Mendis, Q. Gao; J. Wei, “Towards smarter cities: A self-healing resilient Microgrid Social Network” in *Proc. of 2016 IEEE Power and Energy Society General Meeting (PESGM)*, pp: 1 – 5, 2016.
- [16] European Commission, “A strategy for smart, sustainable and inclusive growth”, COM(2010) 2020 final , 2010. Available at url: <http://www.eea.europa.eu/policy-documents/com-2010-2020-europe-2020>
- [17] Paris agreement COP 21. Available at url: <http://www.cop21.gouv.fr/en/what-was-cop21/>
- [18] L. N. Ochoa, F. Pilo, A. Keane, P. Cuffe, G. Pisano, “Embracing an Adaptable, Flexible Posture: Ensuring That Future European Distribution Networks Are Ready for More Active Roles”, in *IEEE Power and Energy Magazine*, vol.14 issue:5, pp.16-28, 2016.
- [19] Schneider Electric, “The Transformation from DNO to DSO”, 2014. Available at url: <http://blog.schneider-electric.com/utilities/2014/11/27/transformation-dno-dso/>
- [20] Council of European Energy Regulators (CEER), “Future Role of DSOs, A CEER conclusions paper”, 2015. Available at url: http://www.ceer.eu/portal/page/portal/EER_HOME/EER_PUBLICATIONS/CEER_PAPERS/Cross-Sectoral/Tab1/C15-DSO-16-03_DSO%20Conclusions_13%20July%202015.pdf

- [21] I. A. Sajjad, G. Chicco, R. Napoli, “Definitions of Demand Flexibility for Aggregate Residential Loads”, in *IEEE Transactions on Smart Grid*, vol.7, issue:6, 2016.
- [22] Smart Cities Council, “Why microgrids will be essential for smart cities”, 2016. Available at url: <http://smartcitiescouncil.com/article/why-microgrids-will-be-essential-smart-cities>
- [23] Ofgem, “Making the electricity system more flexible and delivering the benefits for consumers”, *Position Paper*, 2015
- [24] Environmental Defense Fund, “Putting Demand Response to Work for California”. Available at url: <http://www.edf.org/sites/default/files/demand-response-california.pdf>
- [25] California ISO, “What the duck curve tells us about managing a green grid”, 2016. Available at url: https://www.caiso.com/Documents/FlexibleResourcesHelpRenewables_FastFacts.pdf
- [26] P. Demholm et al., “Overgeneration from Solar Energy in California: A Field Guide to the Duck”, Technical report National Renewable Energy Laboratory, 2015
- [27] Energy Innovation, “Grid flexibility: methods for modernizing the power grid, 2016. Available at url: <http://energyinnovation.org/wp-content/uploads/2016/05/Grid-Flexibility-report.pdf>
- [28] Entsoe, “Network Code on Electricity Balancing”, Draft, 2016. Available at url: <http://www.entsoe.eu/major-projects/network-code-development/electricity-balancing/Pages/default.aspx>
- [29] E. Ela et al., “Operating Reserves and Variable Generation A comprehensive review of current strategies, studies, and fundamental research on the impact that increased penetration of variable renewable generation has on power system operating reserves”, National Renewable Energy Laboratory, 2011
- [30] M. Hummon et al., “Drivers of the Cost and Price of Operating Reserves”, National Renewable Energy Laboratory technical report, 2013.
- [31] O. Ma, N. Alkadi, P. Cappers, P. Denholm, J. Dudley, S. Goli, M. Hummon, S. Kiliccote, J. MacDonald, N. Matson, D. Olsen, C. Rose, M. D. Sohn, M. Starke, B. Kirby, M. O'Malley, “Demand Response for Ancillary Services”, in *IEEE Transactions on Smart Grid*, vol: 4, issue: 4. pp:1988 – 1995, 2013

Chapter IV

- [32] D. S. Watson, et al., “Fast Automated Demand Response to Enable the Integration of Renewable Resources”, Ernest Orlando Lawrence Berkeley National Laboratory, 2012
- [33] IEEE Terminology Task Force, “Glossary of Terms Related to Load Management,” in *IEEE Transaction on Power Apparatus and Systems*, Vol. PAS-104, No. 9, pp. 2381 – 2392, 1985.
- [34] D. Lincoln et al., “Demand Response Pilot Event Conducted August 25, 2011. Summary Report”, Sandia National Laboratories Report. Available at url: <http://prod.sandia.gov/techlib/access-control.cgi/2012/120379.pdf>
- [35] PJM, “Retail Electricity Consumer Opportunities for Demand Response in PJM’s Wholesale Markets”. Available at url: <http://www.pjm.com/~media/markets-ops/dsr/end-use-customer-fact-sheet.ashx>
- [36] North American Electric Reliability Corporation (NERC), “2011 Demand Response Availability Report”, 2013. Available at url; <http://www.nerc.com/docs/pc/dadswg/2011%20DADS%20Report.pdf>
- [37] Q.Zhang, J.Li. “Demand Response in Electricity Markets: A Review”, in *proc of European Energy Market (EEM), 2012 9th International Conference*, pp. 1-8, 2012
- [38] DOE U.S. Department of Energy, “Benefits of Demand Response in electricity markets and recommendations for achieving them, A report to the United States Congress pursuant to section 1252 of the Energy Policy Act of 2005”, 2006.
- [39] Z. Zhou, F. Zhao, J. Wang, "Agent-based electricity market simulation with demand response from commercial buildings," in *IEEE Transactions on Smart Grids*, vol. 2, no. 4, pp. 580-588, 2011.
- [40] J.L. Mathieu, P.N. Price, S. Kiliccote, M.A. Piette, "Quantifying changes in building electricity use, with application to demand response," in *IEEE Transactions on Smart Grids*, vol. 2, no. 3, pp. 507- 518, 2011.
- [41] E. Peeters, D. Six, M. Hommelberg, R. Belhomme, F. Bouffard, “The address project: An architecture and markets to enable active demand”, in *Proc. of European Energy Market (EEM)*, 2009.
- [42] K. Kessel, D. Six, M. T. Mekonnen, B. Dupont, “Feasibility Of Employing Domestic Active Demand For Balancing Wind Power Generation”, in *Proc. European Energy Market (EEM)*, 2013.

- [43] A. Bayod-Rjula, "Future development of the electricity systems with distributed generation", in *Energy*, vol. 34, no. 3, pp. 377-383, 2009.
- [44] ELIA, "ARP Contract Practical Modalities of the Balance obligation". Available at: <http://www.elia.be/~media/files/Elia/Products-and-services/ARP2/Practical%20modalities%20%20imbalance.pdf>
- [45] ELIA, "ELIA Balance Process". Available at url: <http://www.elia.be/en/products-and-services/balance/process>
- [46] ELIA, "ELIA Balancing Mechanism". Available at url: <http://www.elia.be/en/products-and-services/balance/balancing-mechanism>
- [47] Federal Energy Regulatory Commission (FERC), "What FERC does". Available at url: <https://www.ferc.gov/about/ferc-does.asp>
- [48] I. Castillo, G. Gross, "Assessment of the impacts of demand curtailments in the dams: issues in and proposed modifications of FERC order No. 745", Master of Science Thesis, University of Illinois at Urbana Champaign, 2012
- [49] Federal Energy Regulatory Commission (FERC), "Order No. 719-A". Available at url: <http://www.ferc.gov/whats-new/comm-meet/2009/071609/E-1.pdf>
- [50] Federal Energy Regulatory Commission (FERC), "Order No. 745-A". Available at url: <http://www.ferc.gov/whats-new/comm-meet/2011/121511/E-4.pdf>
- [51] California ISO, "Market processes and products". Available at url: <http://www.caiso.com/market/Pages/MarketProcesses.aspx>
- [52] PJM, "Day-Ahead Energy Market". Available at url: <http://www.pjm.com/markets-and-operations/energy/day-ahead.aspx>
- [53] PJM, "Locational Marginal Pricing". Available at url: <http://www.pjm.com/~media/about-pjm/newsroom/fact-sheets/locational-marginal-pricing-fact-sheet.ashx>
- [54] Stoft, "Power System Economics Designing Markets for Electricity", WILEY- IEEE Press, ISBN: 978-0-471-15040-4, 2002
- [55] L. Minghai, G. Gross, "A framework for transmission congestion management analysis", Dissertation, University of Illinois at Urbana Champaign, 2005
- [56] Z. Zhao, L. Wu, "Impacts of High Penetration Wind Generation and Demand Response on LMPs in Day-Ahead Market Optimal Scheduling of Critical Peak Pricing Considering Wind Commitment", in *IEEE Transactions on Smart Grid*, vol.5, pp 220-229, 2014.

Chapter IV

- [57] K. Van Horn, G. Gross, "A comparative assessment of demand response and energy storage resource economic and emission impacts," in *Proc. of IREP Symposium 2013, Bulk Power System Dynamics and Control - IX Optimization, Security and Control of the Emerging Power Grid*, pp.1-9, 2013.
- [58] M. Parvania, M. Fotuhi-Firuzabad, M. Shahidehpour, "ISOs Optimal Strategies for Scheduling the Hourly Demand Response in Day-Ahead Markets", in *IEEE Transaction on Power Systems*, vol.29, pp.2636-2645, 2014.
- [59] L. Wu, "Impact of price-based demand response on market clearing and locational marginal prices", in *IET Generation, Transmission & Distribution*, vol.7, issue:10, pp. 1087-1095, 2013.
- [60] P. Brown, "U.S. Renewable Electricity: How Does Wind Generation Impact Competitive Power Markets?", *Congressional Research Service*, 2012.
- [61] Y. Degeilh, G. Gross, "Stochastic Simulation of Utility-Scale Storage Resources", in *IEEE Transactions on Power Systems*, vol:30, issue:3, pp. 1424 - 1434, 2015
- [62] Y. Degeilh, G. Gross, "Stochastic Simulation of Power Systems with Integrated Intermittent Renewable Resources", in *International Journal of Electrical Power & Energy Systems*, vol. 64, pp.542-550, 2015.
- [63] J. Price and J. Goodin, "Reduced network modeling of WECC as a market design prototype", in *Proc. of the IEEE PES General Meeting*, pp. 16, 2011.
- [64] P. Denholm et al., "The role of energy storage with electricity renewable generation", National Renewable Energy Laboratory technical report, 2010. Available at url: <http://www.nrel.gov/docs/fy10osti/47187.pdf>.
- [65] S. Aggarwal et al. "Two Kinds of Demand-Response" Energy Innovation, 2012. Available at url: <http://energyinnovation.org/wp-content/uploads/2014/11/Two-Kinds-of-Demand-Response.pdf>
- [66] E. Shayesteh, M. Parsa Moghaddam, S. Taherynejhad; M. K. Sheikh-EL-Eslami, "Congestion Management using Demand Response programs in power market" in *Proc of 2008 IEEE Power and Energy Society General Meeting - Conversion and Delivery of Electrical Energy in the 21st Century*, pp: 1 - 8, 2008
- [67] Neas Energy, EA Energy analyses, "Managing congestion in distribution grids- Market design consideration", Report, 2012. Available at url: <http://www.energinet.dk/SiteCollectionDocuments/Danske%20dokumenter/Om%20os/Managing%20congestions%20in%20distri>

- bution%20grids%20-%20Market%20design%20considerations%20v1.pdf
- [68] R. F. Preiss, Warnock, V. J., "Impact of Voltage Reduction on Energy and Demand", in *IEEE Transactions on Power Apparatus and Systems*, vol.PAS-97, no.5, pp.1665,1671, 1978
- [69] C. Reese, C. Buchhagen, L. Hofmann, "Voltage range as control input for OLTC-equipped distribution transformers," in *Proc. on IEEE PES T&D Conf. Expo.*, pp. 1–6, 2012
- [70] C. Reese, C. Buchhagen, and L. Hofmann, "Enhanced method for voltage range controlled OLTC-equipped distribution transformers," in *Proc. IEEE PES General Meeting*, pp. 1–8, 2012
- [71] T. Stetz, F. Marten, and M. Braun, "Improved low voltage grid-integration of photovoltaic systems in Germany," in *IEEE Transaction on Sustainable Energy*, vol. 4, no. 2, pp. 534–542, 2013.
- [72] T. Stetz, K. Diwold, M. Kraiczy, D. Geibel, S. Schmidt, M. Braun, "Techno-economic assessment of voltage control strategies in low voltage grids", in *IEEE Transaction on Smart Grid*, vol. 5, no. 4, pp. 2125–2132, Jul. 2014.
- [73] P. Wang, D. H. Liang, J. Yi, P. F. Lyons, P. J. Davison, P. C. Taylor, "Integrating electrical energy storage into coordinated voltage control schemes for distribution network", in *IEEE Transaction on Smart Grid*, vol. 5, no. 2, pp. 1018–1032, 2014.
- [74] L. Chao Luis F. Ochoa, "Voltage control of PV-rich LV networks: OLTC-fitted transformer and capacitor banks", in *IEEE Transaction on Power Systems*, vol. 31, issue:5, 2016
- [75] GRIdCoN® iTAp® system solution for voltage regulated distribution transformers. Available at: http://www.reinhausen.com/Portaldata/1/Resources/microsites/pd/downloads/Flyer_iTAP_EN.pdf
- [76] The University of Manchester, "Solutions for voltage control options at LV busbars", Report version: 2.0. Available at url: <http://www.enwl.co.uk/docs/default-source/future-lv-busbars/lv-busbars-appendix-3.pdf?sfvrsn=2>
- [77] M. Muratori, B. Schuelke-Leech, G. Rizzoni, "Role of residential demand response in modern electricity markets", in *Renewable and Sustainable Energy Reviews*, vol. 33, pp 546–553, 2014
- [78] ADDRESS European Project. Available at url: http://www.addressfp7.org/index.html?topic=project_vision
- [79] A. Agnetis, G. de Pascale, P. Detti, A. Vicino, "Load Scheduling for Household Energy Consumption Optimization", in

Chapter IV

- IEEE Transactions on Smart Grid*, Vol: 4, Issue: 4, pp.: 2364 - 2373,2013
- [80] CLASS Project. Available at url: <http://www.enwl.co.uk/class>
- [81] Z. Wang; J. Wang, "Review on Implementation and Assessment of Conservation Voltage Reduction", in *IEEE Transactions on Power Systems*, Vol: 29, Issue: 3, pp.: 1306 – 1315, 2014
- [82] R. W. Beck, "Distribution Efficiency Initiative Final Report", Northwest Energy Efficiency Alliance Report, 2007. Available at url: <http://neea.org/docs/default-source/rfp's/longterm-monitoring-and-tracking-distribution-efficiency.pdf?sfvrsn=4>.
- [83] A. Ballanti, L. N.F. Ochoa, "Initial Assessment of Voltage-Led Demand Response from UK Residential Loads" in *Proc. of IEEE PES ISGT*, 2015
- [84] U.S. Department of Energy, "Evaluation of Conservation Voltage Reduction (CVR) on a National Level", July 2010
- [85] K. Schneider et al., "Modern Grid Initiative Distribution Taxonomy Final Report", Pacific Northwest National Laboratory (PNNL) Report, 2008. Available at url: http://www.gridlabd.org/models/feeders/taxonomy_of_prototypical_feeders.pdf
- [86] K. Torvik, Utilities Boost Efficiency with Smart CVR, Navigant Research, 2014.
- [87] L. G. Lagos; L. F. Ochoa, "CVR assessment in UK residential LV networks considering customer types", in *Proc. of 2016 IEEE Innovative Smart Grid Technologies - Asia (ISGT-Asia)*, pp: 741 – 746, 2016
- [88] I. Richardson, M. Thomson, D. Infield, C. Clifford, Domestic electricity use: a high-resolution energy demand model, in *Energy and Buildings*, vol.42, issue: 10, pp. 1878–1887, 2010
- [89] A. Bokhari, A. Alkan, R. Dogan, M. Diaz-Aguilo, F. Leon, D.Czarkowski, Z. Zabar, L. Birenbaum, A. Noel and R. E. Uosef, "Experimental Determination of the ZIP Coefficients for Modern Residential, Commercial, and Industrial Loads," in *IEEE Transaction on Power Delivery*, vol. 29, no. 3, pp. 1372-1381, 2014
- [90] A. Ballanti, L.N. Ochoa "WP2 Part A - Final Report "Offline Capability Assessment", 2015. Available at url: <http://www.enwl.co.uk/docs/default-source/class-documents/offline-demand-response-capability-assessment-final-report.pdf?sfvrsn=4>

- [91] G. Tsagarakis, A. J. Collin, A. E. Kiprakis, and S. McLaughlin, "Voltage control of UK residential customers for power reduction", in *Proc. of IEEE 2013 PowerTech*, pp. 1-6, 2013.
- [92] F. Lamberti, D. Cuicai, V. Calderaro, L. F. Ochoa, "Estimating the load response to voltage changes at UK primary substations", in *Proc. of Innovative Smart Grid Technologies Europe (ISGT EUROPE)*, pp. 1-5, 2013.
- [93] EPRI, "Volt/VAR Control and Optimization Concepts and Issues". Available at url: <http://cialab.ee.washington.edu/nwess/2012/talks/uluski.pdf>
- [94] Voltage Characteristics in Public Distribution Systems, CEI EN 50160, May, 2011
- [95] A. Navarro-Espinosa, L. F. Ochoa, "Increasing the PV hosting capacity of LV networks: OLTC-fitted transformers vs. reinforcements", in *Proc of 2015 IEEE PES Innovative Smart Grid Technologies Conference (ISGT)*, 2015.
- [96] W. Xie, P. Benren, Yong Li, Shuaihu Li, Yijia Cao. "A New Energy Efficiency Management and Control Strategy of Grid-Friendly-Based Intelligent Electricity", in *Proc. of Power System Technology (POWERCON), 2014 International Conference*, 2014
- [97] L. Dongwook, H. Minsoo, P. Sangjun, L. Seunghyung, "User Position Estimation and Visualization Using Power Consumption of Home Appliances", in *Proc. of IT Convergence and Security (ICITCS)*, 2014
- [98] Hussain, S, Ikram, M.J.; Arshad, N. "A Low Cost Implementation of Home Area Networks for Home Energy Management Systems", in *Proc. of Big Data and Cloud Computing (BdCloud), 2014 IEEE Fourth International Conference*, 2014.
- [99] Subhash, B., Rajagopal, V. "Overview of smart metering system in Smart Grid scenario", in *Proc. of Power and Energy Systems Conference: Towards Sustainable Energy*, 2014.
- [100] T. Ganu, D.P. Seetharam, V. Arya, R. Kunnath, J. Hazra, S.A. Husain, L.C. De Silva, S. Kalyanaraman, "nPlug: A smart plug for alleviating peak loads", in *Proc of Future Energy Systems: Where Energy, Computing and Communication Meet (e-Energy)*, 2012
- [101] J. M. Bloemink; T. C. Green, "Benefits of Distribution-Level Power Electronics for Supporting Distributed Generation Growth", in *IEEE Transactions on Power Delivery*, vol.28, pp.:911-919, 2013

Chapter IV

- [102] IEC 61000-3-2:2014, Electromagnetic compatibility (EMC) - Part 3-2: Limits - Limits for harmonic current emissions (equipment input current ≤ 16 A per phase). TC 77/SC 77A - EMC - Low frequency phenomena
- [103] ACS750SCA-050, Fully Integrated, Hall Effect-Based Linear Current Sensor IC with High Voltage Isolation and a Low-Resistance Current Conductor, Allegro microsystem. Available at URL: <http://www.allegromicro.com/~Media/Files/Datasheets/ACS750-050-Datasheet.ashx> , visited on January 2016.
- [104] AD8436, Low Cost, Low Power, True RMS-to-DC Converter, Analog Devices. Available at URL: <http://www.analog.com/en/products/linear-products/rms-to-dc-converters/ad8436.html>, visited on January 2016.
- [105] Powerline AC/DC converter RECOM RAC 02- 05SC. Available at URL: http://www.recompower.com/pdf/Powerline-ACDC/RAC10-S_DC_277.pdf , visited on January 2016.
- [106] Snubberless T3035H High- temperature 30 A Triac- ST Microelectronics. Available at url: http://www.st.com/web/catalog/sense_power/FM144/CL1221/SC547/PF250339, visited on January 2016.
- [107] MOC3020 Optocoupler/Optoisolator, Fairchild. Available at URL: <http://www.ti.com/lit/ds/symlink/moc3020.pdf>, visited on January 2016
- [108] MSP430G2x52, MSP430G2x12 Mixed Signal Microcontroller, Texas Instruments. Available at URL: <http://www.ti.com/product/msp430g2252>, visited on January 2016
- [109] P. W. Wheeler; J. Rodriguez; J. C. Clare; L. Empringham; A. Weinstein, "Matrix converters: a technology review" in *IEEE Transactions on Industrial Electronics*, vol: 49, issue: 2, pp: 276 - 288, 2002
- [110] A. De Caro "Progetto e realizzazione di un convertitore AC/AC per la modulazione del carico elettrico su smart grids", Master of Science in Electronics Engineering at Univeristy of Salerno, tutor: Prof. V. Galdi, co-tutor: P.Santoro, 2016
- [111] Voltage Optimisation System. Available at URL <https://vo4.co.uk/>, visited on January 2016
- [112] ATLANTIDE project. Available at url: <http://www.progettoatlantide.it/>
- [113] Allegato A della Delibera ARG/elt 81/10 dell'Autorità per l'Energia Elettrica e Gas, "Monitoraggio dello sviluppo degli impianti di generazione distribuita per gli anni 2007 e 2008".

- Available at url:
<http://www.autorita.energia.it/allegati/docs/10/081-10argall.pdf>
- [114] Enel Energy contract. Available at url:
<https://www.enelservizioelettrico.it/it-IT/contatore>
- [115] I. Richardson and M. Thomson, "Domestic electricity demand model simulation example," ed. January 2010.
- [116] OPENDSS Tool. Available at url:
<http://electricdss.sourceforge.net/>